

K A F L A R N I A KAFEL-KAR



Katalog produktów
Wydanie VII. Ceny ważne od 1 stycznia 2024

Spis Treści

Warunki realizacji zamówień i formy płatności _____ 2

KAFLE

| | |
|--|------------|
| KAFLE „CLASSIC” | 5 |
| PIECYK „ECHO” | 9 |
| KAFLE „BRAMA” | 10 |
| KAFLE „TALERZ CIĘTY” | 11 |
| KAFLE „GŁADKIE” | 12 |
| KAFLE „RAMKOWE” | 15 |
| KAFLE „DWORSKIE” | 18 |
| KAFLE „FORMAT” 28cm | 24 |
| KAFLE „OGARKI” | 26 |
| KAFLE „VINTAGE” | 30 |
| KAFLE „FORMAT” 44cm | 37 |
| KAFLE „GABARYT” | 39 |
| KOMPLETY KAFLI „RÓŻA”, „RAJSKI PTAK” | 40 |
| KAFLE „MILITARY” | 42 |
| DEFLEKTORY | 44 |
| KAFLE PÓŁKI „6” | 45 |
| KAFLE WIEŃCOWE „6” | 46 |
| PÓŁKI „3” SLIM | 47 |
| KAFLE PÓŁKI „WYSOKIE” | 48 |
| KAFLE PÓŁKI „SECESJA” | 49 |
| KAFLE PÓŁKI „ZDOBIONE” | 50 |
| KAFLE PÓŁKI „VINTAGE” | 51 |
| LISTWY DYSTANSOWE | 52 |
| COKOŁY | 55 |
| GZYMSY | 57 |
| KAFLE WYKOŃCZENIOWE, DEKORACYJNE | 67 |
| KAFLE „SECESJA” | 71 |
| PIEC OKRĄGŁY KLASYCZNY | 77 |
| PIEC OKRĄGŁY „OGAREK Ø 90” | 83 |
| PIEC OKRĄGŁY „OGAREK Ø 66” | 91 |
| KAFLE „RURA CERAMICZNA Z ROZETAMI” | 94 |
| PIECE MINIATURY | 95 |
| KAFLE „KWADRATELE” | 97 |
| KOLORYSTYKA KAFLI | 98 |
| PRZYKŁADY ZLECEŃ INDYWIDUALNYCH | 100 |
| KAFLE MALOWANE I ZDOBIONE | 103 |
| FORMULARZE REALIZACJI ZAMÓWIEŃ | 107 |
| WZORY KAFLI | 116 |

**KAFLE PIECOWE I KOMINKOWE
– CHARAKTERYSTYKA I ZASTOSOWANIE**

Dziękujemy za zainteresowanie i chcemy przybliżyć Państwu nasz wyrób, zarówno pod kątem produkcyjnym, jak i użytkowym, oraz zapoznać z warunkami gwarancji.

Wytwarzanie ceramiki kaflowej to cenione na świecie rzemiosło, będące efektem pracy ludzkich rąk. Pomimo rozwoju przemysłu i cywilizacji, głównymi wytwórcami kafli piecowych i kominkowych są nadal niewielkie manufaktury, oparte na rodzinnej tradycji – tak jak w naszej kaflarni.

Kafle ceramiczne to elementy konstrukcyjne i jednocześnie zdobnicze pieca lub kominka. Dzięki swoim właściwościom odbierają one energię z żywego ognia, by następnie gromadzić ją i przekazywać do pomieszczenia jako miłe i łagodne promieniowanie ciepłe.

Kafle to wyrób z materiałów i surowców wyłącznie naturalnych, głównie z różnych mieszanek gliny i szamotu. Wysoka temperatura w trakcie przetwarzania i kilkukrotnego wypalania przekształca glinę w materiał ekologiczny i zdrowy w użytkowaniu. Nabiera on właściwości, których nie mają inne materiały budowlane, jest funkcjonalny i trwały, a także potrafi przetrwać w nienaruszonym stanie przez kilka stuleci.

Cechą kafli przy ogrzewaniu jest powierzchniowe wyrównanie ciepła, wydostającego się z wnętrza pieca. Jest to najzdrowszy i najlepszy dla człowieka sposób ogrzewania pomieszczeń mieszkalnych. Promieniowanie łagodnym ciepłem poprzez duże powierzchnie grzewcze pieca czy kominka kaflowego, w miejsce grzejnikowego ogrzewania konwekcyjnego, całkowicie zmienia rozkład temperatur w domu na korzystniejszy. Nie przesusza pomieszczeń i daje dużo większy komfort cieplny dla ludzkiego ciała.

Równie istotny jest aspekt ekonomiczny – drewno jest najtańszym źródłem energii. Co ważne, jest to jedyny w pełni odnawialny surowiec paliwowy.

Piękno i estetykę kafli podkreśla się poprzez zdobienie różnokolorowymi szkliwami, płaskorzeźbami, reliefami oraz ozdobnym malowaniem. Różnorodność i swoboda wyboru przy tworzeniu i aranżacji brył pieców i kominków dają projektantom i wykonawcom ogromne pole do popisu.

Wszelkie walory ceramiki kaflowej mają swoje tło, które je tworzy i określa jako materiał nieujarzmiony i zróżnicowany pod kątem składu chemicznego i fizycznego. Dlatego traktujemy go jako „żywy” materiał, wymagający pokory i codziennych kompromisów. Jednocześnie te cechy nadają kafelkom ich indywidualny charakter, tak często poszukiwany przez koneserów rzemieślniczego wyrobu i pragnienie posiadania niepowtarzalnych, naturalnych przedmiotów rękodzieła. Jako producenci ceramiki piecowej i kominkowej rozumiemy, że ten indywidualny charakter wyrobu jest największą zaletą dla Nabywcy.

Przyjmując życzenia naszych Klientów, zawsze informujemy i podkreślamy, aby wachlarz oczekiwań rozszerzyć o występujące różnice, zgodnie z naturalnymi cechami wypalanej gliny i szkliwa.

Z wyrazami szacunku



Rafał Karny

WARUNKI REALIZACJI ZAMÓWIEŃ

1. **Kafłarnia Kafel-Kar Rafał Karny, 15-378 Białystok, Hryniewicze 3B, NIP 9661341458, zwana dalej Producentem**, jest manufakturą ceramiczną, która przyjmuje i realizuje indywidualne zamówienia na ceramikę kaflową według oferty www.kafel-kar.pl. Celem Producenta jest wykonanie zamówienia zgodnie z dostarczoną specyfikacją.
2. Realizacja zamówienia następuje na podstawie pisemnego zlecenia, -ozonego przez klienta, zwanego dalej Zamawiającym, według specyfikacji podanej przez Zamawiającego oraz po akceptacji niniejszych warunków i postanowień podanych przez Producenta.
3. Przyjęcie zamówienia i wpłata zaliczki za przedmiot zamówienia jest ostateczną akceptacją wykonania zlecenia oraz niniejszych warunków i postanowień. Data wpływu środków na konto Producenta rozpoczyna okres oczekiwania.
4. Standardowy czas realizacji zamówienia ustala się na 4–8 tygodni z zastrzeżeniem wydłużenia lub skrócenia tego okresu w formie powiadomienia telefonicznego lub drogą mailową.
5. Producent realizuje zamówienia wg specyfikacji podanej przez Zamawiającego, wobec powyższego nie ponosi odpowiedzialności za wynikiłe niezgodności z projektem. Wszystkie dodatkowe, a niewynikające ze standardowego wykonania elementów prace powinny być zgłoszone w formie rysunków i opisane przy zamówieniu jako załącznik. Dotyczy to dodatkowego cięcia i niestandardowego szklwienia, różnych nietypowych boków kafla, elementów itp.
6. Przedstawiona kolorystyka kafla na stronie internetowej, w katalogach oraz we wzornikach może nieznacznie odbiegać od kolorów będących w bieżącej produkcji.
7. Przy wybarwieniu szklwiami transparentnymi mogą występować przebarwienia oraz nieznaczne różnice w odcieniach ich kolorystyki niestanowiące wady produktu. Przebarwienia i cieniowania koloru są cechą charakterystyczną tych szklwii i główną cechą ozdobną.
8. Przy wyborze szklwii matowych Producent nie ponosi odpowiedzialności za niewłaściwe obchodzenie się z kaflami przy montażu, a zwłaszcza przy fugowaniu i czyszczeniu powierzchni. Producent każdorazowo może przeszkolić Zamawiającego i Wykonawcę po uprzednim zgłoszeniu. Dotyczy to szklwii szczególnie wrażliwych na nieprawidłowe fugowanie i czyszczenie, takich jak (zgodnie ze stroną IT) szklwiwo: 21 Beż Mat, 22 Vanilia Mat, 23 Perła Mat, 24 Cappucino Mat, 26 Lawenda Mat, 72 Grafit Mat, 29 Róż Wenecki Mat, 32 Sahara Mat, 33 Sienna Mat, 75 Brąz Metaliczny, 51 Beż Cracle Mat, 53 Popielaty Cracle.
9. Szklwiwo efektowne, takie jak: 75 Metaliczny Brąz, 71 Czerwień Zachodu, 76 Orange połysk, z reguły charakteryzują się dużą różnorodnością wybarwienia i niepowtarzalnością. Ta odważna stylizacja i pozorne niedopasowanie w jednym, -ożeniu jest celem i siłą wywoływanego wrażenia. Ta inspirująca cecha powinna zawsze prowadzić do uwzględnienia tego faktu przy zamówieniu.
10. Dobór identycznych kafla (jak w przypadku glazury ściiennej czy podłogowej) w przypadku kafla piecowych i kominkowych **nie jest celem produkcyjnym i nie jest możliwy!** Tolerancja wymiarowa kafla, produktów i elementów ceramicznych wynosi $\pm 0,5\%$.
11. Naturalną cechą produkcyjną kafla są słabo widoczne włosowate zarysowania, które mogą wystąpić na płaszczyznach kafla. Nie mają one wpływu na podstawową funkcję i trwałość przedmiotu zamówienia oraz nie mogą być przedmiotem roszczeń reklamacyjnych.
12. **Zamawiający oświadcza, że ma kwalifikacje branżowe do oceny i montażu zamówionego produktu i jest przeszkolony w zakresie BHP. W przypadku braku odpowiednich kwalifikacji wymagany jest nadzór branżowy mistrza zdunskiego.**

13. Producent do montażu kafli zaleca stosowanie materiałów zgodnie z ich przeznaczeniem. Nie dopuszcza się i nie przyjmuje ewentualnych reklamacji spowodowanych nieprzestrzeganiem obowiązujących przepisów i norm budowlanych.
14. Producent zaleca, aby czyszczenie kaflowej obudowy przeprowadzić ze szczególną starannością. Czyszczenie powinno być wykonane przy pomocy suchej lub lekko zwilżonej ścierki z zastosowaniem łagodnych płynów czyszczących do powierzchni glazurowanej. W przypadku kafli zdobionych **złotem lub platyną** nie należy stosować środków żrących, ściernych i powierzchniowo czynnych, z zachowaniem szczególnej ostrożności.
15. Zamawiający po otrzymaniu przesyłki lub przy odbiorze osobistym jest zobowiązany do sprawdzenia zgodności odebranego towaru ze, -ożonym zamówieniem i dodatkowymi późniejszymi ustaleniami. Zawsze należy dokonać przeglądu zamówienia. Rozłożyć wszystkie elementy i dokonać kontrolnego, -ożenia obudowy kaflowej na płaszczyźnie, przeglądu, kompletacji oraz odcieni i wybarwienia kafli. Nadwyżki zamawianych elementów nie będą przyjmowane do zwrotu.
16. Koszty wysyłki zamówienia firmą kurierską pokrywa Zamawiający.
17. Reklamacje dotyczące ewentualnych niezgodności zgłoszone w terminie późniejszym niż 7 dni od daty odbioru towaru nie będą rozpatrywane. Działanie osób trzecich oraz siły wyższej będzie przedmiotem odrębnego postępowania po wcześniejszej informacji zwrotnej do Producenta, jednak nie później niż 24 godziny od daty odbioru dostawy.
18. Producent pozostaje właścicielem całości zamówienia do momentu zapłaty całości faktury lub rachunku w uzgodnionej formie.
19. W rozstrzyganiu ewentualnych sporów i reklamacji stroną dla Producenta jest zawsze Zamawiający i zapisy kodeksu cywilnego.
20. Wpłata zaliczki jest równoznaczna z akceptacją niniejszych warunków Producenta.

Zapoznałem(-łam) się z charakterystyką produktu oraz warunkami realizacji zamówienia:











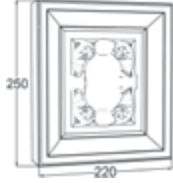

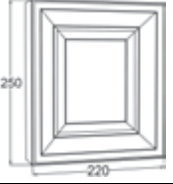

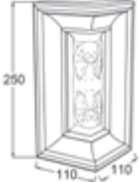
DATA I PODPIS KLIENTA

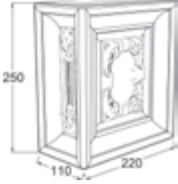
Wykonawca Kaflarnia Kafel-Kar

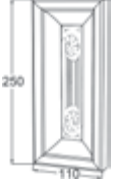

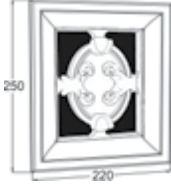
Rafał Karny

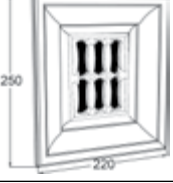

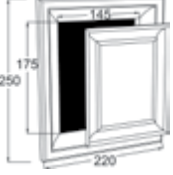
KAFLE „CLASSIC” – NOWOŚĆ !

| Symbol | Fotografia | Rysunek (wymiary w mm) | Pełna nazwa (wymiary w mm) |
|--------|---|---|--|
| Ca01 |  |  | KAFEL ŚRODKOWY 250 x 220 x 55 |
| Ca02 |  |  | KAFEL ŚRODKOWY GŁADKI 250 x 220 x 55 |
| Ca03 |  |  | KAFEL NAROŻNY OSTRY 250 x 110 x 110 |
| Ca04 |  |  | KAFEL NAROŻNY OSTRY „L” 250 x 220 x 110 |
| Ca05 |  |  | KAFEL POŁÓWKA ½ 250 x 110 x 55 |
| Ca06 |  |  | KAFEL ŚRODKOWY Z WYWIETRZNIKIEM „1” 250 x 220 x 55 |
| Ca07 |  |  | KAFEL ŚRODKOWY Z WYWIETRZNIKIEM „2” 250 x 220 x 55 |
| Ca08 |  |  | KAFEL ŚRODKOWY REWIZYJNY 250 x 220 x 55 (otwór 145 x 175) |

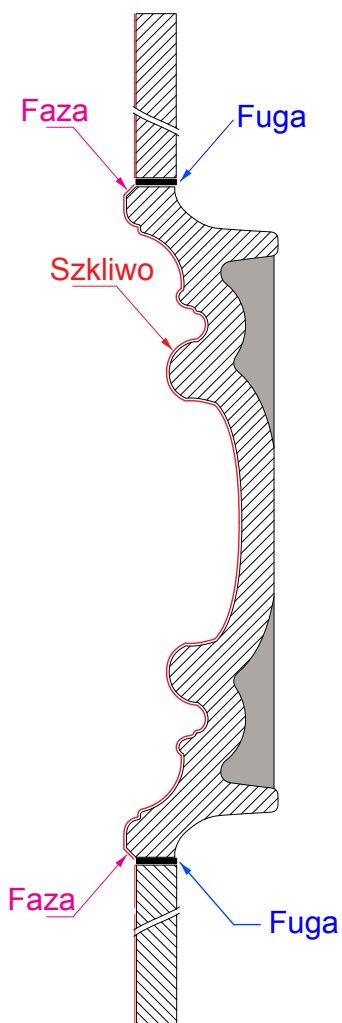
Ca01



Ca09

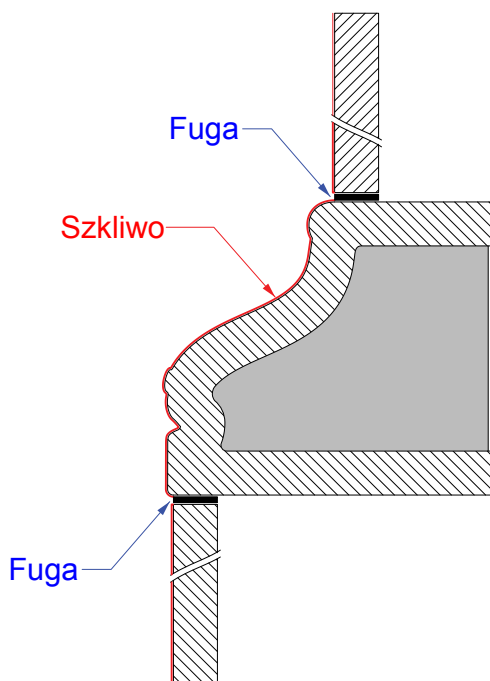

Ca09/1

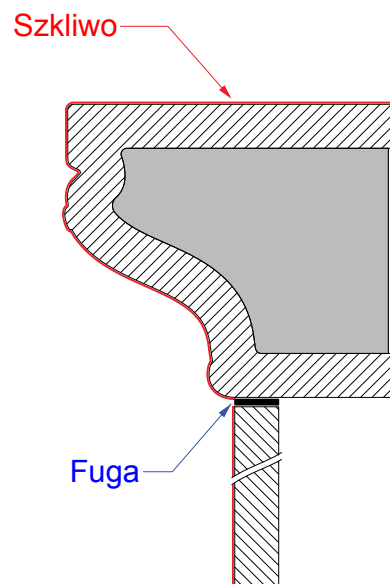



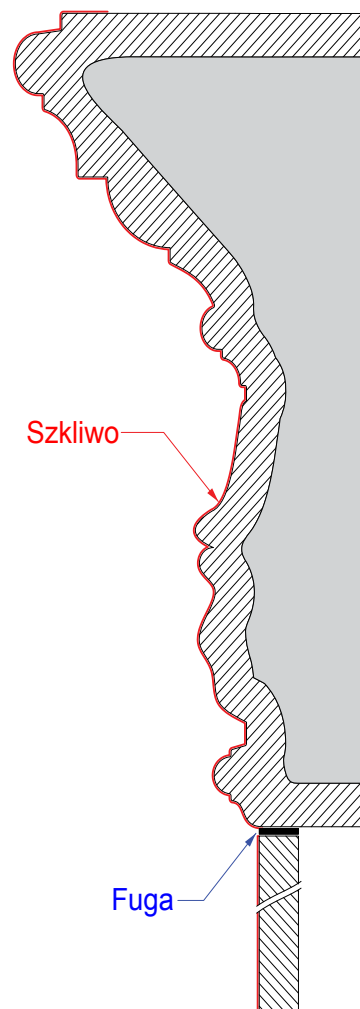



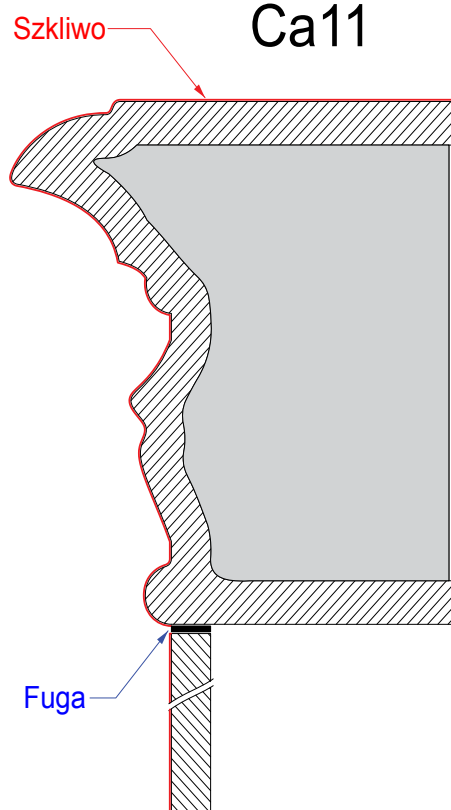

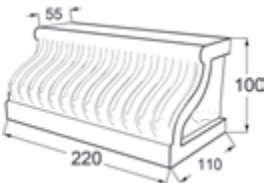

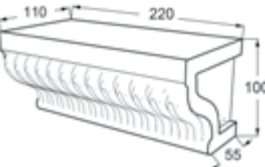

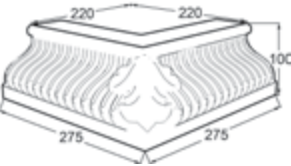
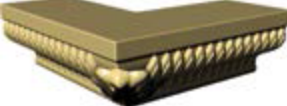
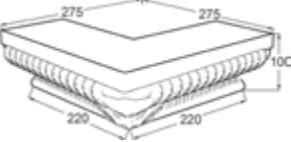

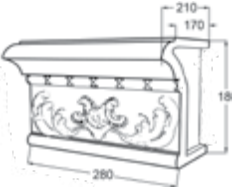
Ca14

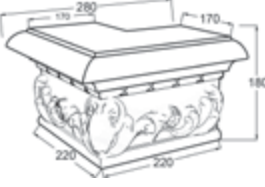



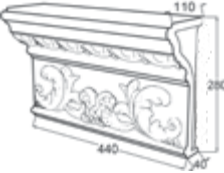

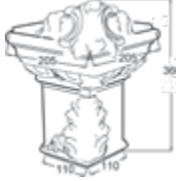





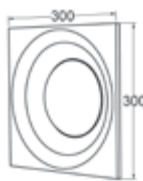

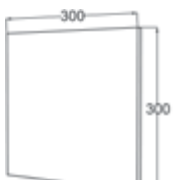

Ca11

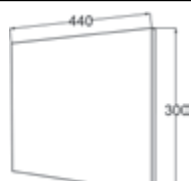





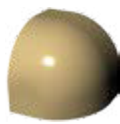



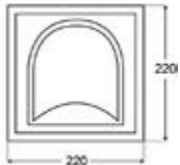

| Symbol | Fotografia | Rysunek (wymiary w mm) | Pełna nazwa (wymiary w mm) |
|--------|---|---|--|
| Ca09 |  |  | GZYMS ŚRODKOWY PRZEWĘŻENIE 220 x 55 x 100, 220 x 110 |
| Ca09/1 |  |  | GZYMS ŚRODKOWY 220 x 110, 220 x 55 x 100 |
| Ca10 |  |  | GZYMS NAROŻNY PRZEWĘŻENIE 220 x 220 x 100, 275 x 275 |
| Ca10/1 |  |  | GZYMS NAROŻNY 275 x 275, 220 x 220 x 100 |
| Ca11 |  |  | PÓŁKA ŚRODKOWA 280 x 170 x 180, 280 x 210 |
| Ca12 |  |  | PÓŁKA ROGOWA 280 x 280 x 180 dół 220 x 220 x 180 półka 170 x 170 |
| Ca13 |  |  | KORONA Z NAROŻNIKAMI 890 x 680 x 110 |
| Ca14 |  |  | GZYMS WIEŃCZĄCY ŚRODKOWY 440 x 280 x 110 Podstawa 440 x 40 |
| Ca15 |  |  | GZYMS WIEŃCZĄCY NAROŻNY Podstawa 110 x 110 Góra 205 x 205 Wysokość całkowita 360 |





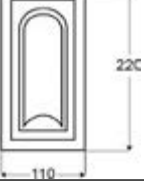

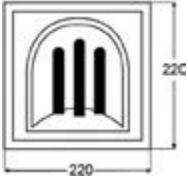





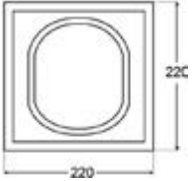

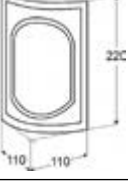

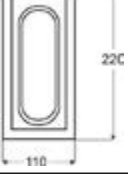
Piecyk „ECHO” – NOWOŚĆ !

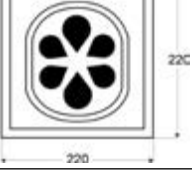
| Symbol | Fotografia | Rysunek (wymiary w mm) | Pełna nazwa (wymiary w mm) |
|---------------|---|---|---|
| Ec01w |  |  | KAFEL ŚRODKOWY 300 x 300 x 55 (wewnętrzny) |
| Ec01z |  |  | KAFEL ŚRODKOWY 300 x 300 x 55 (zewnątrzny) |
| Ec02 |  |  | KAFEL ŚRODKOWY „I” 300 x 300 x 20 (kafel bez rompy) |
| Ec03 |  |  | KAFEL ŚRODKOWY „II” 440 x 300 x 20 (kafel bez rompy) |
| Ec04 |  |  | KAFEL ŚRODKOWY „III” 440 x 200 x 20 (kafel bez rompy) |
| Ec05 |  |  | KAFEL NAROŻNY ZAKOŃCZONY „I” 300 x 110 x 110 |
| Gb07 |  |  | KAFEL NAROŻNY ZAKOŃCZONY 440 x 110 x 110 |
| Gb08/ Kp20 |  |  | KAFEL NAROŻNY ZAMYKAJĄCY ZAKOŃCZONY 110 x 110 x 110 (kafel bez rompy) |

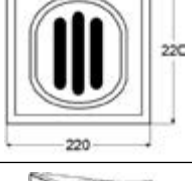



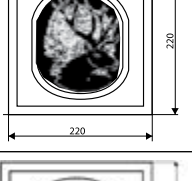







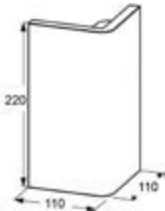

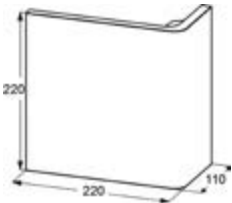
KAFLE „BRAMA”





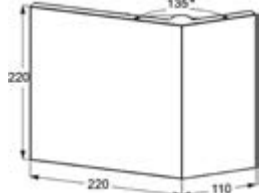

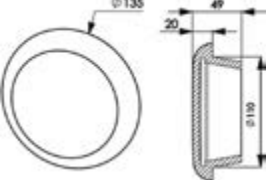

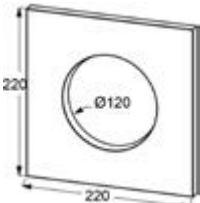

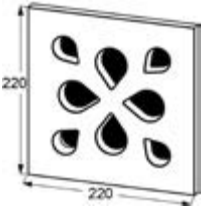

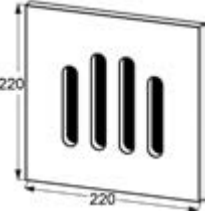

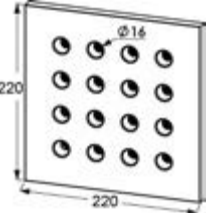
| Symbol | Fotografia | Rysunek (wymiary w mm) | Pełna nazwa (wymiary w mm) |
|--------|---|---|--|
| Kb01 |  |  | KAFEL ŚRODKOWY 220 x 220 x 50 |
| Kb02 |  |  | KAFEL NAROŻNY ZAKRĄGLONY 220 x 110 x 110 |
| Kb03 |  |  | KAFEL NAROŻNY OSTRY 220 x 110 x 110 |
| Kb04 |  |  | KAFEL POŁÓWKA 1/2 220 x 110 x 50 |
| Kb05 |  |  | KAFEL ŚRODKOWY Z WYWIETRZNIKIEM 220 x 220 x 50 |
| Kb06 |  |  | KAFEL OZDOBNY „SOWA” 220 x 220 x 50 |



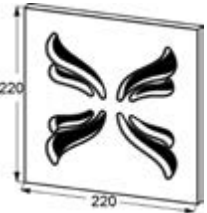

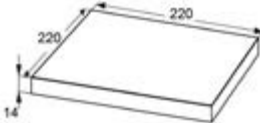

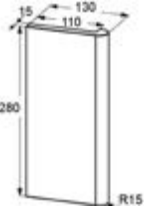

KAFLE „TALERZ CIĘTY”

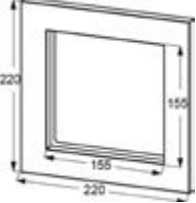
| Symbol | Fotografia | Rysunek (wymiary w mm) | Pełna nazwa (wymiary w mm) |
|--------|---|---|--|
| Kt01 |  |  | KAFEL ŚRODKOWY 220 x 220 x 50 |
| Kt02 |  |  | KAFEL NAROŻNY ZAKRĄGLONY 220 x 110 x 110 |
| Kt03 |  |  | KAFEL POŁÓWKA ½ 220 x 110 x 50 |
| Kt04 |  |  | KAFEL ŚRODKOWY Z WYWIETRZNIKIEM „1” 220 x 220 x 50 |
| Kt05 |  |  | KAFEL ŚRODKOWY Z WYWIETRZNIKIEM „2” 220 x 220 x 50 |
| Kt06 |  |  | KAFEL NAROŻNY OSTRY 220 x 110 x 110 |
| Kt07 |  |  | KAFEL OZDOBNY „JELEŃ” 220 x 220 x 50 |
| Kt08 |  |  | KAFEL OZDOBNY „SOWA” 220 x 220 x 50 |

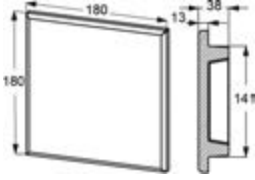
KAFLE „GŁADKIE”

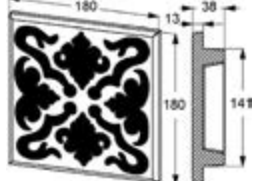
| Symbol | Fotografia | Rysunek (wymiary w mm) | Pełna nazwa (wymiary w mm) |
|--------|---|---|--|
| Kp01 |  |  | KAFEL ŚRODKOWY 220 x 220 x 50 |
| Kp02 |  |  | KAFEL NAROŻNY OSTRY 220 x 110 x 110 |
| Kp03 |  |  | KAFEL NAROŻNY OSTRY „L” 220 x 220 x 110 |
| Kp04 |  |  | KAFEL POŁÓWKA ½ 220 x 110 x 50 |
| Kp05 |  |  | KAFEL NAROŻNY ZAKRĄGLONY 220 x 220 x 110 |
| Kp16 |  |  | KAFEL NAROŻNY ROZWARTY 135° 220 x 220 x 110 |
| Kp06 |  |  | KOREK OKRĄGŁY Ø135 |
| Kp07 |  |  | KAFEL Z OTWOREM OKRĄGŁYM Ø120 220 x 220 x 50 <i>Dostępny Korek Kp06 (Kafle Gładkie)</i> |

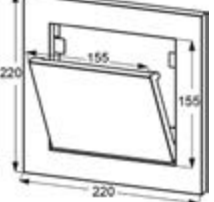

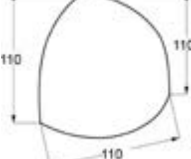



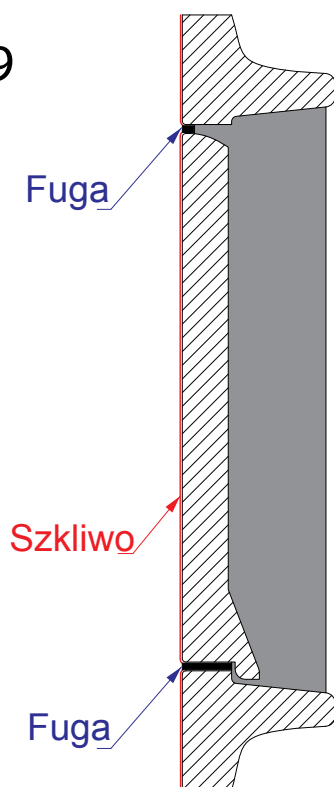



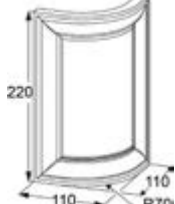

| | | | |
|--------------|---|---|--|
| Kp08 |  |  | KAFEL ŚRODKOWY Z WYWIETRZNIKIEM „1” 220 x 220 x 50 |
| Kp09 |  |  | KAFEL ŚRODKOWY Z WYWIETRZNIKIEM „2” 220 x 220 x 50 |
| Kp10 |  |  | KAFEL ŚRODKOWY Z WYWIETRZNIKIEM „3” 220 x 220 x 50 |
| Kp17 |  |  | KAFEL ŚRODKOWY Z WYWIETRZNIKIEM „4” 220 x 220 x 50 |
| Kp18 |  |  | KAFEL ŚRODKOWY Z WYWIETRZNIKIEM „5” 220 x 220 x 50 |
| Kp11/ K02 |  |  | PŁYTKA ŚRODKOWA 220 x 220 x 14 |
| Kp12 |  |  | PŁYTKA ŚRODKOWA 250 x 220 x 14 |
| Kp13 |  |  | LISTWA MASKUJĄCA BRZEGOWA „1” 280 x 130 x 30 |

| | | | |
|---------------|---|---|--|
| Kp14 |  |  | <p>KAFEL Z OTWOREM KWADRATOWYM 155 x 155, 220 x 220 x 50 <i>Dostępny Korek Kp15, Kp15a (kafle Gładkie)</i></p> |
| Kp15 |  |  | <p>KOREK KWADRATOWY 180 x 180 x 38</p> |
| Kp15a |  |  | <p>KOREK KWADRATOWY Z WYWIETRZNIKIEM 180 x 180 x 38</p> |
| Kp19 |  |  | <p>KAFEL REWIZYJNY 220 x 220 x 50 (otwór 155 x 155)</p> |
| Kp20/ Gb08 |  |  | <p>KAFEL NAROŻNY ZAMYKAJĄCY ZAOKRĄGLONY 110 x 110 x 110 (kafel bez rompy)</p> |

Kp19

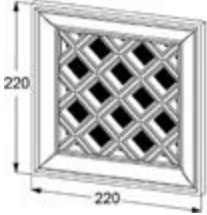

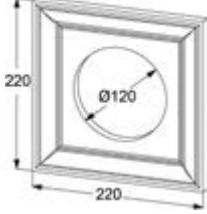

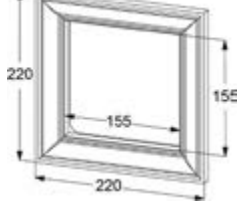







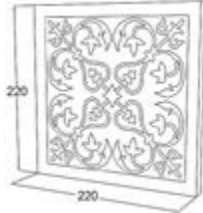

KAFLE „RAMKOWE”

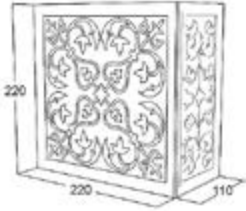



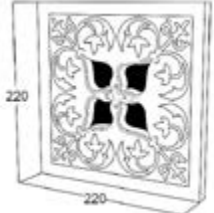

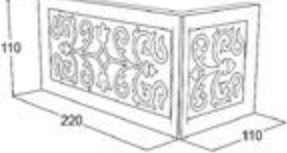



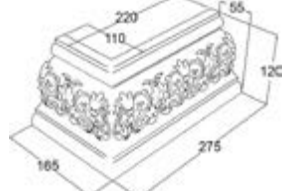

| Symbol | Fotografia | Rysunek (wymiary w mm) | Pełna nazwa (wymiary w mm) |
|--------|---|---|--|
| Ra01 |  |  | KAFEL ŚRODKOWY 220 x 220 x 50 |
| Ra02 |  |  | KAFEL NAROŻNY ZAKRĄGLONY 220 x 110 x 110 |
| Ra03 |  |  | KAFEL NAROŻNY OSTRY 220 x 110 x 110 |
| Ra04 |  |  | KAFEL POŁÓWKA ½ 220 x 110 x 50 |
| Ra05 |  |  | KAFEL ŚRODKOWY Z WYWIETRZNIKIEM 220 x 220 x 50 |
| Ra06 |  |  | KAFEL Z OTWOREM OKRĄGLYM Ø120 220 x 220 x 50 <i>Dostępny Korek Kp06 (kafle Gładkie)</i> |
| Ra07 |  |  | KAFEL Z OTWOREM KWADRATOWYM 155 x 155, 220 x 220 x 50 <i>Dostępny Korek Kp15, Kp15a (kafle Gładkie)</i> |

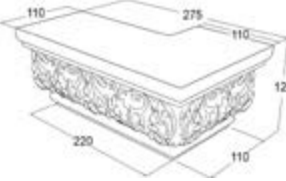

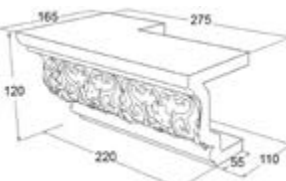

KAFLE „DWORSKIE”

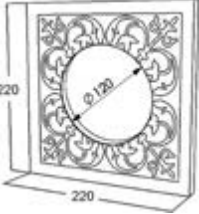
| Symbol | Fotografia | Rysunek (wymiary w mm) | Pełna nazwa (wymiary w mm) |
|--------|---|---|--|
| Dw01 |  |  | KAFEL ŚRODKOWY 220 x 220 x 50 |
| Dw02 |  |  | KAFEL NAROŻNY OSTRY 220 x 110 x 110 Uwaga R-2 |
| Dw03 |  |  | KAFEL NAROŻNY „L” 220 x 220 x 110 Uwaga R-2 |
| Dw04 |  |  | KAFEL POŁÓWKA ½ 220 x 110 x 50 |
| Dw05 |  |  | KAFEL ŚRODKOWY Z WYWIETRZNIKIEM 220 x 220 x 50 |
| Dw06 |  |  | KAFEL NAROŻNY ½ „L” 220 x 110 x 110 Uwaga R-2 |
| Dw07 |  |  | GZYMS ŚRODKOWY 220 x 120 x 110 |

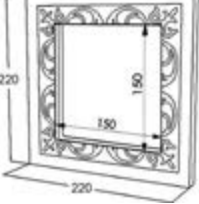
| | | | |
|---------|---|---|--|
| Dw07/1 |  |  | GZYMS ŚRODKOWY 220 x 120 x 110 |
| Dw09L |  |  | GZYMS NAROŻNY OSTRY 220 x 110 x 120, 275 x 165 Uwaga R-2 |
| Dw09L/1 |  |  | GZYMS NAROŻNY OSTRY 275 x 165, 220 x 110 x 120 Uwaga R-2 |
| Dw09P |  |  | GZYMS NAROŻNY OSTRY 220 x 110 x 120, 275 x 165 Uwaga R-2 |
| Dw09P/1 |  |  | GZYMS NAROŻNY OSTRY 275 x 165, 220 x 110 x 120 Uwaga R-2 |
| Dw10 |  |  | KAFEL Z OTWOREM OKRĄGŁYM Ø120 220 x 220 x 50 Dostępny Korek Kp06 (kafle Gładkie) |
| Dw11 |  |  | KAFEL Z OTWOREM KWADRATOWYM 150 x 150, 220 x 220 x 50 Dostępny Korek Kp15, Kp15a (kafle Gładkie) |

Dw07

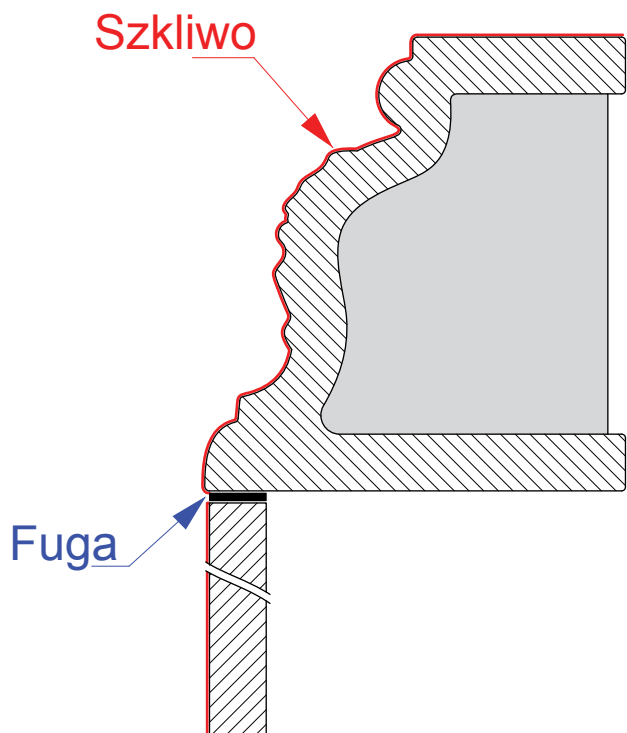



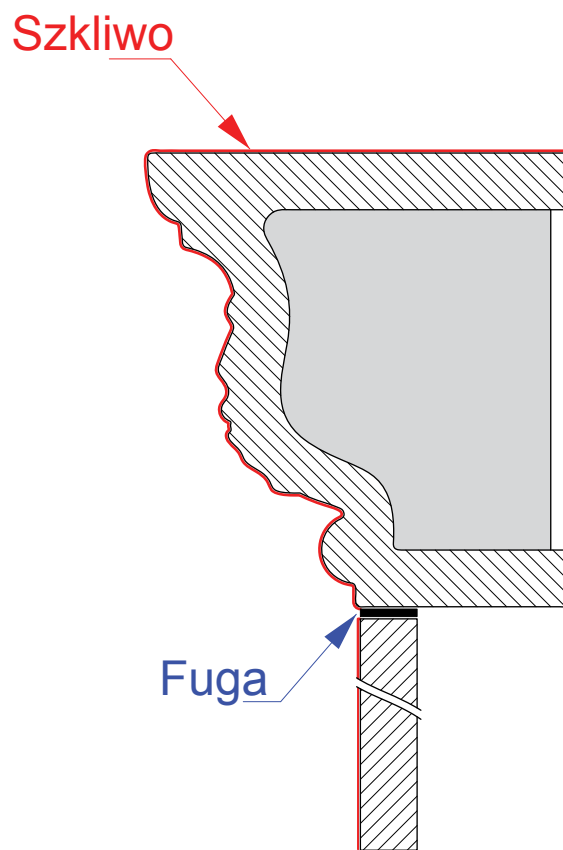



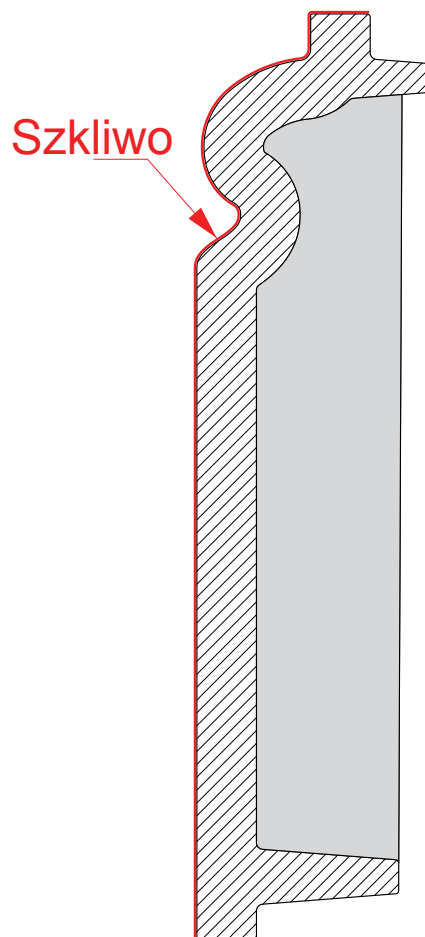

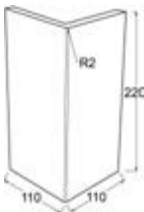
Dw07/1

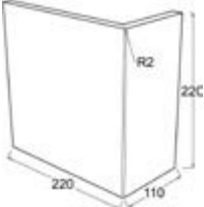

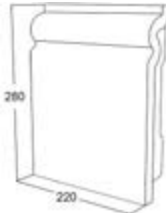
C10

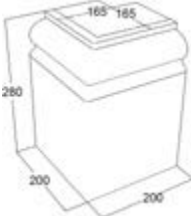

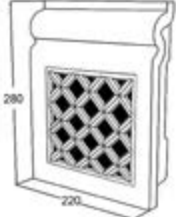













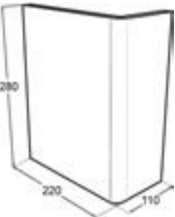



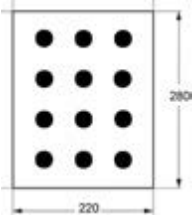





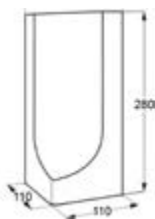

| Symbol | Fotografia | Rysunek (wymiary w mm) | Pełna nazwa (wymiary w mm) |
|--------|---|---|--|
| Dw12 |  |  | KAFEL NAROŻNY OSTRY 220 x 110 x 110 Uwaga R-2, GŁADKI |
| Dw13 |  |  | KAFEL NAROŻNY OSTRY „L” 220 x 220 x 110 Uwaga R-2, GŁADKI |
| C10 |  |  | COKÓŁ ŚRODKOWY „DWORSKIE” 220 x 280 x 70 |
| C11 |  |  | COKÓŁ NAROŻNY „DWORSKIE” 165 x 165 x 280, 200 x 200 |
| C12 |  |  | COKÓŁ ŚRODKOWY Z WYWIETRZNIKIEM „DWORSKIE” 220 x 280 x 70 |

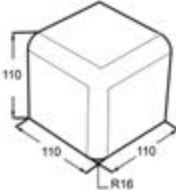

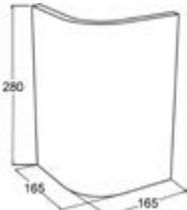

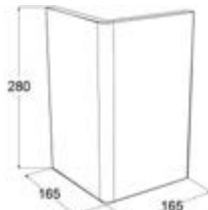

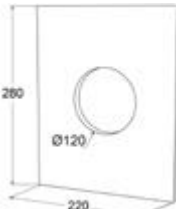

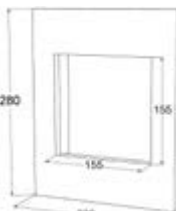

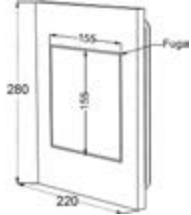

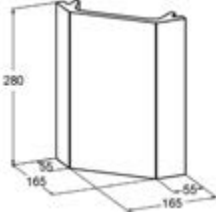



KAFLE „FORMAT” 28 cm















| Symbol | Fotografia | Rysunek (wymiary w mm) | Pełna nazwa (wymiary w mm) |
|--------|---|---|--|
| Fm01 |  |  | KAFEL ŚRODKOWY 280 x 220 x 50 |
| Fm02 |  |  | KAFEL NAROŻNY ZAKRĄGLONY 280 x 110 x 110 |
| Fm03 |  |  | KAFEL NAROŻNY OSTRY 280 x 110 x 110 |
| Fm14 |  |  | KAFEL NAROŻNY OSTRY „L” 280 x 220 x 110 |
| Fm04 |  |  | KAFEL POŁÓWKA ½ 280 x 110 x 50 |
| Fm05 |  |  | KAFEL ŚRODKOWY Z WYWIETRZNIKIEM „1” 280 x 220 x 50 |
| Fm11 |  |  | KAFEL ŚRODKOWY Z WYWIETRZNIKIEM „2” 280 X 220 X 50 |

| | | | |
|------|---|---|--|
| Fm06 |  |  | KAFEL NAROŻNY OSTRY ZEWNĘTRZNY 280 x 110 x 110 |
| Fm07 |  |  | KAFEL NAROŻNY WEWNĘTRZNY 280 x 110 x 110 |
| Fm08 |  |  | KAFEL NAROŻNY ZAMYKAJĄCY 110 x 110 x 110 (bez rompy) |
| Fm09 |  |  | KAFEL NAROŻNY ZAOKRĄGLONY 280 x 165 x 165 |
| Fm10 |  |  | KAFEL NAROŻNY OSTRY 280 x 165 x 165 |
| Fm12 |  |  | KAFEL Z OTWOREM OKRĄGLYM Ø120 280 x 220 x 50 <i>Dostępny Korek Kp06 (kafle Gładkie)</i> |
| Fm13 |  |  | KAFEL Z OTWOREM KWADRATOWYM 155 x 155, 280 x 220 x 50 <i>Dostępny Korek Kp15, Kp15a (kafle Gładkie)</i> |

| | | | |
|------|---|---|--|
| Fm15 |  |  | KAFEL REWIZYJNY 280 x 220 x 50 (OTWÓR 155 x 155) |
| Fm16 |  |  | KAFEL NAROŻNY ŁAMANY 280 x 165 x 165 |
| Fm17 |  |  | KAFEL ŚRODKOWY Z WYWIETRZNIKIEM „3” 280 x 220 x 50 |
| Fm18 |  |  | KAFEL ŚRODKOWY Z WYWIETRZNIKIEM „4” 280 x 220 x 50 |
| Fm19 |  |  | PŁYTKA ŚRODKOWA 280 x 220 x 14 |
| Fm20 |  |  | KAFEL OZDOBNY „ARCHANIOŁ” 280 x 220 x 50 |

KAFLE „OGARKI”











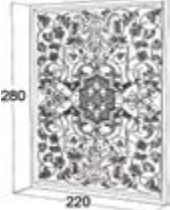

| Symbol | Fotografia | Rysunek (wymiary w mm) | Pełna nazwa (wymiary w mm) |
|--------|---|---|----------------------------------|
| Og01 |  |  | KAFEL ŚRODKOWY 280 x 220 x 50 |



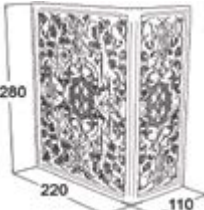

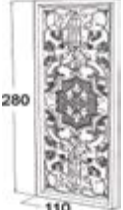

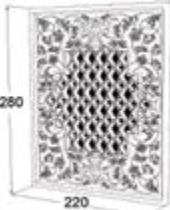

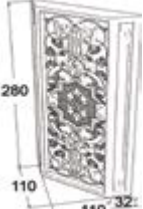

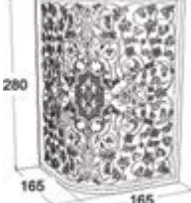

| | | | |
|------|---|---|--|
| Og02 |  |  | KAFEL NAROŻNY ZAKRĄGLONY 280 x 110 x 110 |
| Og03 |  |  | KAFEL NAROŻNY OSTRY 280 x 110 x 110 |
| Og04 |  |  | KAFEL POŁÓWKA ½ 280 x 110 x 50 |
| Og05 |  |  | KAFEL NAROŻNY ZAKRĄGLONY 280 x 165 x 165 |
| Og06 |  |  | KAFEL NAROŻNY OSTRY 280 x 165 x 165 |
| Og07 |  |  | KAFEL ŚRODKOWY Z WYWIETRZNIKIEM 280 x 220 x 50 |
| Og08 |  |  | KAFEL Z OTWOREM OKRĄGLYM Ø120 280 x 220 x 50 <i>Dostępny korek Kp06 (kafle Gładkie)</i> |

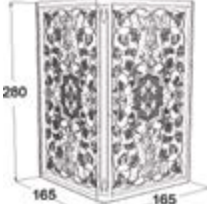

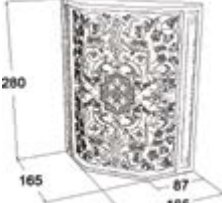

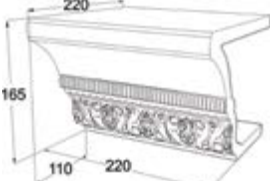
KAFLE „VINTAGE”

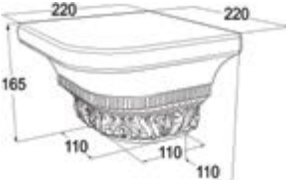
| Symbol | Fotografia | Rysunek (wymiary w mm) | Pełna nazwa (wymiary w mm) |
|--------|---|---|--|
| V01 |  |  | KAFEL ŚRODKOWY 280 x 220 x 50 |
| V02 |  |  | KAFEL NAROŻNY ZAKRĄGLONY 280 x 110 x 110 |
| V03 |  |  | KAFEL NAROŻNY OSTRY 280 x 110 x 110 |
| V04 |  |  | KAFEL NAROŻNY OSTRY „L” 280 x 220 x 110 |
| V05 |  |  | KAFEL POŁÓWKA ½ 280 x 110 x 50 |
| V06 |  |  | KAFEL ŚRODKOWY Z WYWIETRZNIKIEM 280 x 220 x 50 |
| V07 |  |  | KAFEL NAROŻNY ŁAMANY 280 x 110 x 110 |

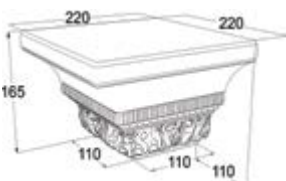
| | | | |
|-----|---|---|--|
| V08 |  |  | KAFEL ĆWIARTKA ¼ 280 x 55 |
| V09 |  |  | KAFEL NAROŻNY ZAKRĄGLONY 280 x 165 x 165 |
| V10 |  |  | KAFEL NAROŻNY OSTRY 280 x 165 x 165 |
| V11 |  |  | KAFEL NAROŻNY ŁAMANY 280 x 165 x 165 |
| V12 |  |  | PÓŁKA ŚRODKOWA 220 x 165 x 220 |
| V13 |  |  | PÓŁKA ROGOWA ZAKRĄGLONA 220 x 220, 110 x 110 x 165 |
| V14 |  |  | PÓŁKA ROGOWA OSTRY 220 x 220, 110 x 110 x 165 |





Szkliwo

V12

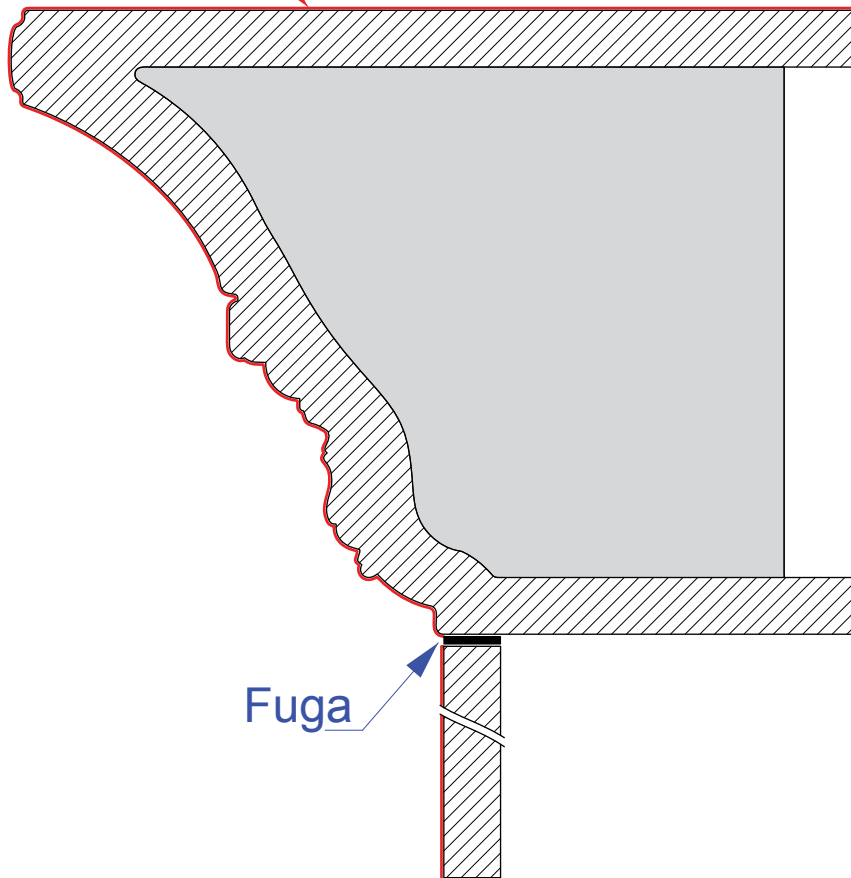





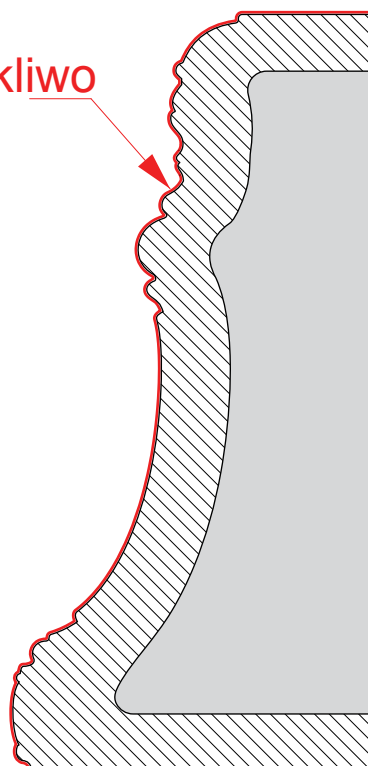

C14

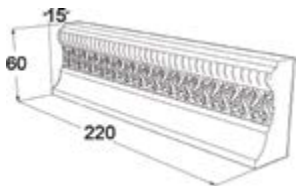
Szkliwo

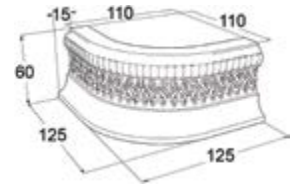

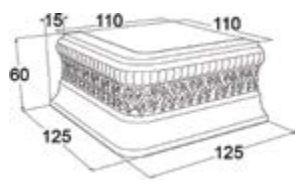

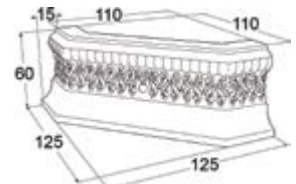



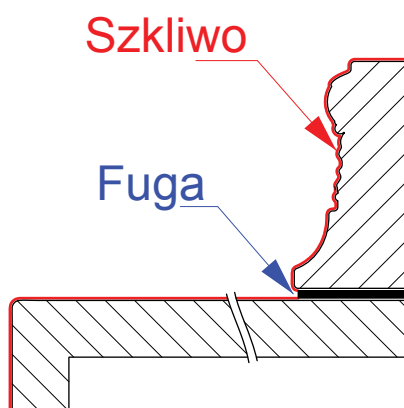





| Symbol | Fotografia | Rysunek (wymiary w mm) | Pełna nazwa (wymiary w mm) |
|--------|---|---|--|
| V15 |  |  | PÓŁKA ROGOWA ŁAMANA 220 x 220, 110 x 110 x 165 |
| V16 |  |  | NOWOŚĆ! PÓŁKA ROGOWA 135° 220 x 220, 110 x 110 x 165 |
| C14 |  |  | COKÓŁ ŚRODKOWY „VINTAGE” 220 x 200 x 90 |
| C15 |  |  | COKÓŁ NAROŻNY ZAKRĄGLONY „VINTAGE” 165 x 165 x 200, 220 x 220 |
| C16 |  |  | COKÓŁ NAROŻNY OSTRY „VINTAGE” 165 x 165 x 200, 220 x 220 |
| C17 |  |  | COKÓŁ NAROŻNY ŁAMANY „VINTAGE” 165 x 165 x 200, 220 x 220 |
| C18 |  |  | COKÓŁ ŚRODKOWY Z WYWIETRZNIKIEM „VINTAGE” 220 x 200 x 90 |
| C19 |  |  | COKÓŁ ŚRODKOWY 135° „VINTAGE” 110 x 110 x 200 |





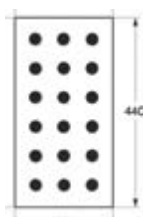

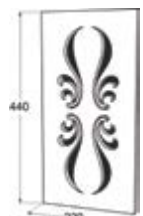

| Symbol | Fotografia | Rysunek (wymiary w mm) | Pełna nazwa (wymiary w mm) |
|--------|--|--|--|
| Ld13 |  |  | LISTWA DYSTANSOWA ŚRODKOWA „VINTAGE” 220 x 60 |
| Ld14 |  |  | LISTWA DYSTANSOWA NAROŻNA ZAOKRĄGLONA „VINTAGE” 110 x 110 x 60 |
| Ld15 |  |  | LISTWA DYSTANSOWA NAROŻNA OSTRZA „VINTAGE” 110 x 110 x 60 |
| Ld16 |  |  | LISTWA DYSTANSOWA NAROŻNA ŁAMANA „VINTAGE” 110 x 110 x 60 |

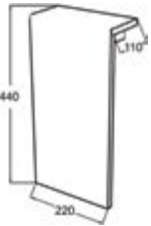
Ld13

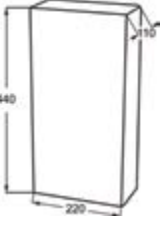

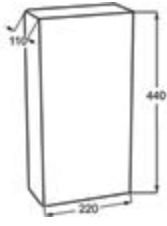
KAFLE „FORMAT” 44 cm

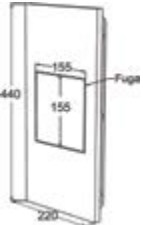





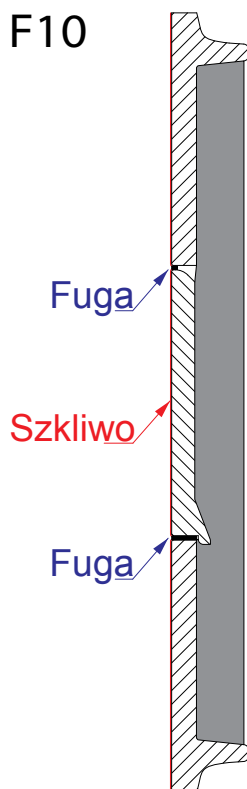



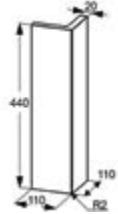

| Symbol | Fotografia | Rysunek (wymiary w mm) | Pełna nazwa (wymiary w mm) |
|--------|---|---|--|
| F01 |  |  | KAFEL ŚRODKOWY 440 x 220 x 45 |
| F02 |  |  | KAFEL NAROŻNY ZAKRĄGLONY 440 x 110 x 110 |
| F03 |  |  | KAFEL NAROŻNY OSTRY 440 x 110 x 110 |
| F04 |  |  | KAFEL POŁÓWKA ½ 440 x 110 x 45 |
| F05 |  |  | KAFEL ŚRODKOWY Z WYWIETRZNIKIEM „1” 440 x 220 x 45 |
| F09 |  |  | KAFEL ŚRODKOWY Z WYWIETRZNIKIEM „2” 440 x 220 x 45 |
| F06 |  |  | KAFEL NAROŻNY „L” 440 x 220 x 110 |

| Symbol | Fotografia | Rysunek (wymiały w mm) | Pełna nazwa (wymiały w mm) |
|--------|---|---|--|
| F07 |  |  | KAFEL NAROŻNY „L” typ II 440 x 220 x 110 |
| F08P |  |  | KAFEL NAROŻNY ZAMYKAJĄCY PRAWY 440 x 220 x 110 |
| F08L |  |  | KAFEL NAROŻNY ZAMYKAJĄCY LEWY 440 x 220 x 110 |
| F10 |  |  | KAFEL REWIZYJNY 440 x 220 x 45 (OTWÓR 155 x 155) |
| F11 |  |  | PŁYTKA ŚRODKOWA 440 x 220 x 14 |

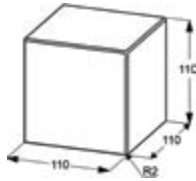

F10



KAFLE „GABARYT”

| Symbol | Fotografia | Rysunek (wymiary w mm) | Pełna nazwa (wymiary w mm) |
|--------|---|---|--|
| Gb02 |  |  | KAFEL ŚRODKOWY 660 x 440 x 20 (kafel bez rompy) |
| Gb03 |  |  | KAFEL ŚRODKOWY 440 x 440 x 20 (kafel bez rompy) |
| Gb04 |  |  | KAFEL NAROŻNY 440 x 110 x 110, R2 (kafel bez rompy) |
| Gb05 |  |  | KAFEL NAROŻNY WIĘCZĄCY 660 x 110 x 110, R2 (kafel bez rompy) |
| Gb06 |  |  | KAFEL NAROŻNY ZAMYKAJĄCY 110 x 110 x 110, R2 (kafel bez rompy) |
| Gb07 |  |  | KAFEL NAROŻNY ZAOKRĄGLONY 440 x 110 x 110 (kafel bez rompy) |
| Gb08 |  |  | KAFEL NAROŻNY ZAMYKAJĄCY ZAOKRĄGLONY 110 x 110 x 110 (kafel bez rompy) |

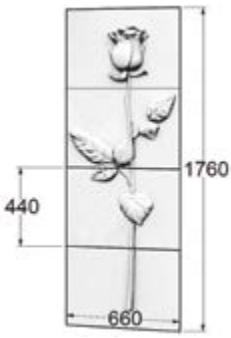





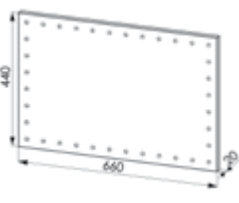

KOMPLETY KAFLI „RÓŻA”, „RAJSKI PTAK”

| Symbol | Fotografia | Rysunek (wymiary w mm) | Pełna nazwa (wymiary w mm) |
|--------|--|--|--|
| Gb_A |  |  | „RÓŻA” Komplet kafli 4 szt. 660 x 440 x 20 (kafel bez rompy) |
| Gb_B |  |  | „RAJSKI PTAK” Komplet kafli 8 szt. 440 x 440 x 20 (kafel bez rompy) |

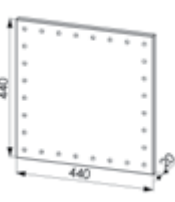

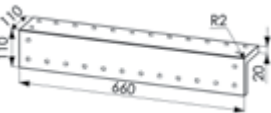

KAFLE „MILITARY”

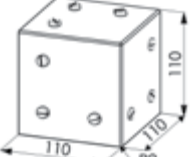
| Symbol | Fotografia | Rysunek (wymiary w mm) | Pełna nazwa (wymiary w mm) |
|--------|---|---|---|
| Gm01 |  |  | KAFEL ŚRODKOWY 660 x 440 x 20 (kafel bez rompy) |
| Gm02 |  |  | KAFEL ŚRODKOWY 440 x 440 x 20 (kafel bez rompy) |
| Gm03 |  |  | KAFEL NAROŻNY 440 x 110 x 110, R2 (kafel bez rompy) |
| Gm04 |  |  | KAFEL NAROŻNY WIĘCZĄCY 660 x 110 x 110, R2 (kafel bez rompy) |
| Gm05 |  |  | KAFEL NAROŻNY ZAMYKAJĄCY 110 x 110 x 110, R2 (kafel bez rompy) |



DEFLEKTORY







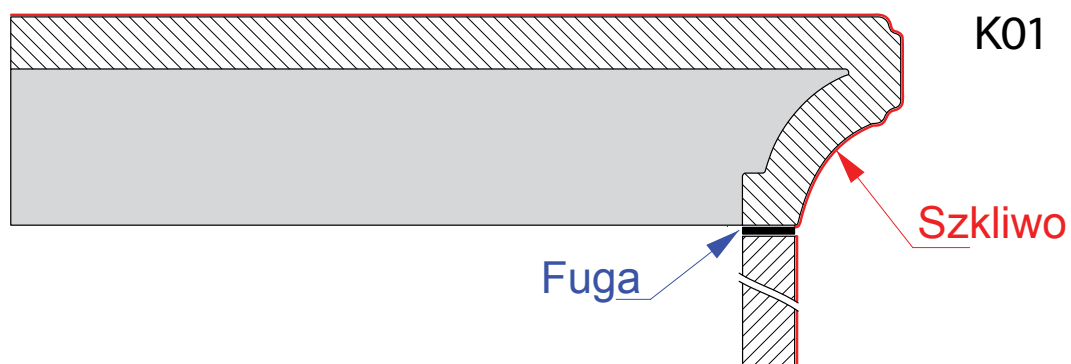

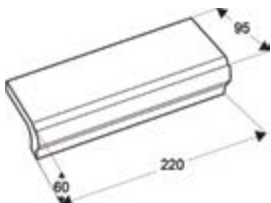

| Symbol | Fotografia | Rysunek (wymiary w mm) | Pełna nazwa (wymiary w mm) |
|--------|------------|---------------------------|--|
| Df01 | | | DEFLEKTOR KAFLI 220 200 x 200 x 35 <i>Kafle z wywietrznikiem: Kb05, Kp08, Kp09, Kp10, Kp17, Kp18, Kt04, Kt05, Dw05, Ra05, Z14</i> |
| Df02 | | | DEFLEKTOR KAFLI 280 250 x 200 x 35 <i>Kafle z wywietrznikiem: Fm05, Fm11, Og07, V06, OrM07</i> |
| Df03 | | | DEFLEKTOR KAFLI 440 415 x 200 x 35 <i>Kafle z wywietrznikiem: F05, F09</i> |
| Df04 | | | DEFLEKTOR KAFLI Ko09 (z wywietrznikiem) 230 x 175 x 30 |
| Df05 | | | DEFLEKTOR KAFLI Ko10 (z wywietrznikiem) 280 x 200 x 35 |
| Df06 | | | DEFLEKTOR KAFLI Or12 (z wywietrznikiem) 330 x 230 x 30 |
| Df07 | | | DEFLEKTOR KAFLI Or15 (z wywietrznikiem) 360 x 280 x 35 |

KAFLE PÓŁKI „6”

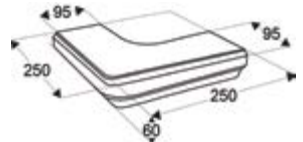

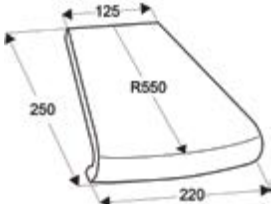

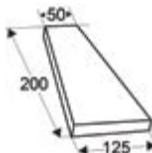



| Symbol | Fotografia | Rysunek (wymiary w mm) | Pełna nazwa (wymiary w mm) |
|--------------|------------|---------------------------|--|
| K01 | | | PÓŁKA ŚRODKOWA 220 x 250 x 60 |
| K01/1 | | | PÓŁKA ŚRODKOWA 250 x 250 x 60 |
| K02/ Kp11 | | | PÓŁKA ŚRODKOWA KRYJĄCA 220 x 220 x 17 |
| K03 | | | PÓŁKA ROGOWA ZAKRĄGLONA 250 x 250 x 60 |
| K04 | | | PÓŁKA ROGOWA OSTRĄ 250 x 250 x 60 |
| K05 | | | PÓŁKA ROGOWA OSTRA 135° 110 x 110 x 60 |

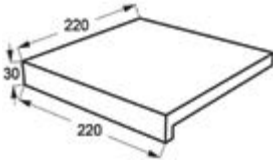

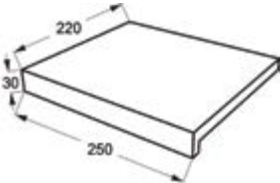
KAFLE WIEŃCOWE „6”



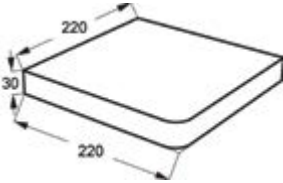

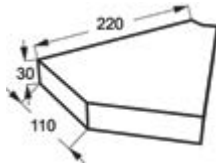

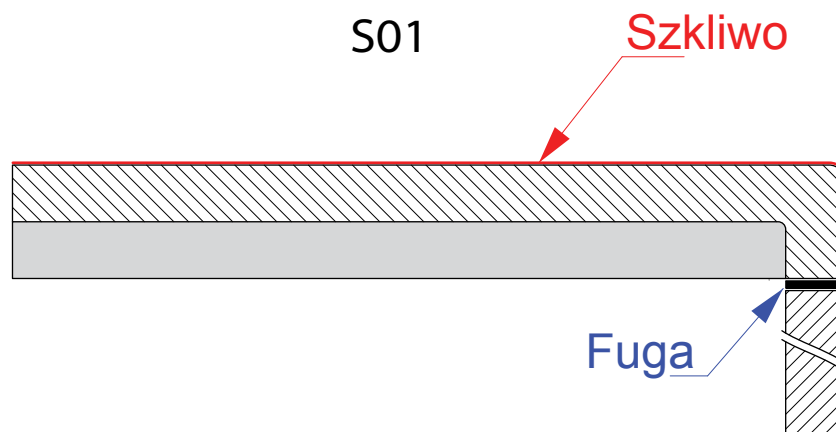
| Symbol | Fotografia | Rysunek (wymiary w mm) | Pełna nazwa (wymiary w mm) |
|--------|---|---|---|
| K06 |  |  | KAFEL WIEŃCOWY ŚRODKOWY 220 x 95 x 60 |
| K07 |  |  | KAFEL WIEŃCOWY NAROŻNY ZAKRĄGLONY 250 x 250 x 60 |
| K08 |  |  | KAFEL WIEŃCOWY NAROŻNY OSTRY 250 x 250 x 60 |
| K09 |  |  | PÓŁKA R 550 220 x 250 x 125 |
| K10 |  |  | ELEMENT DO PÓŁKI K09 R 550, 125 x 200 x 50 |
| K11 |  |  | KAFEL WIEŃCOWY OSTRY 135° 110 x 110 x 60 |

PÓŁKI „3” SLIM

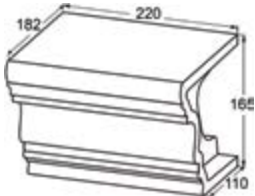
| Symbol | Fotografia | Rysunek (wymiary w mm) | Pełna nazwa (wymiary w mm) |
|--------|---|---|--|
| S01 |  |  | PÓŁKA ŚRODKOWA 220 x 220 x 30 |
| S02 |  |  | PÓŁKA ŚRODKOWA 250 x 220 x 30 |
| S03 |  |  | PÓŁKA ROGOWA ZAKRĄGLONA 220 x 220 x 30 |
| S04 |  |  | PÓŁKA ROGOWA OSTRĄ 220 x 220 x 30 |
| S05 |  |  | PÓŁKA ROGOWA OSTRĄ 135° 110 x 110 x 30 |

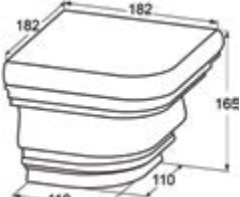

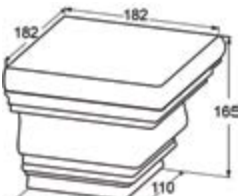
KAFLE PÓŁKI „WYSOKIE”

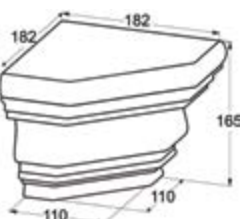
| Symbol | Fotografia | Rysunek (wymiary w mm) | Pełna nazwa (wymiary w mm) |
|--------|---|---|--|
| Kz01 |  |  | PÓŁKA ŚRODKOWA 220 x 182 x 165 GŁADKA |
| Kz02 |  |  | PÓŁKA NAROŻNA ZAOKRĄGLONA 182 x 182 x 165, 110 x 110 GŁADKA |
| Kz03 |  |  | PÓŁKA NAROŻNA OSTRA 182 x 182 x 165, 110 x 110 GŁADKA |
| Kz04 |  |  | PÓŁKA NAROŻNA ŁAMANA 182 x 182 x 165, 110 x 110 GŁADKA |

Szklivo

Kz01

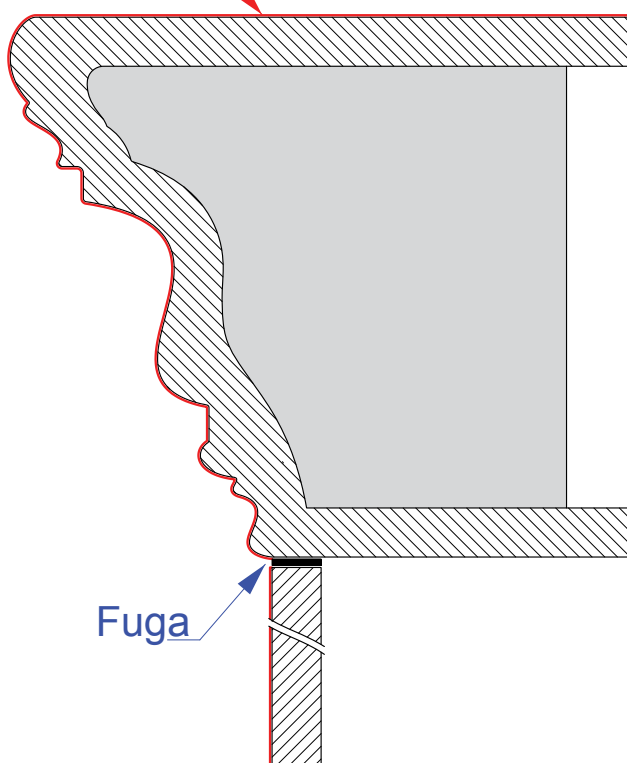





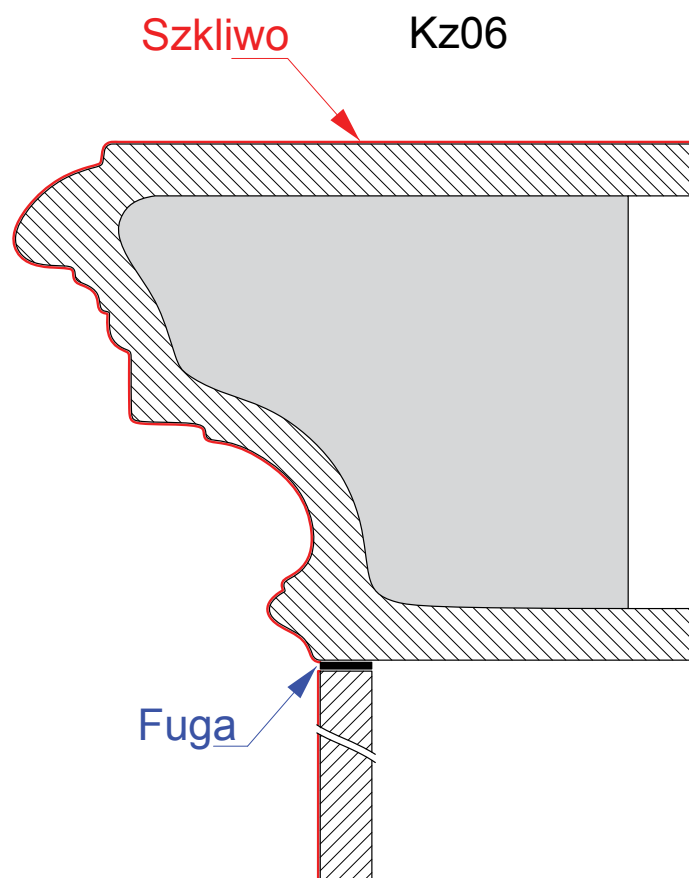

KAFLE PÓŁKI „SECESJA”

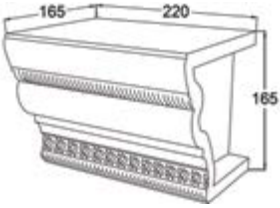
| Symbol | Fotografia | Rysunek (wymiary w mm) | Pełna nazwa (wymiary w mm) |
|--------|------------|---------------------------|--|
| Kz06 | | | PÓŁKA ŚRODKOWA 220 x 170 x 150, 220 x 110 |
| Kz07 | | | PÓŁKA NAROŻNA OSTRA 170 x 170 x 150, 110 x 110 |

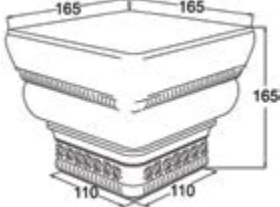

KAFLE PÓŁKI „ZDOBIONE”

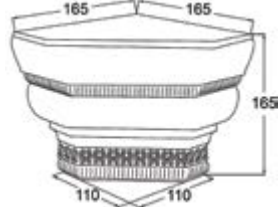
| Symbol | Fotografia | Rysunek (wymiary w mm) | Pełna nazwa (wymiary w mm) |
|--------|---|---|---|
| Pz01 |  |  | PÓŁKA ŚRODKOWA 220 x 165 x 165 |
| Pz02 |  |  | PÓŁKA NAROŻNA ZAKRĄGLONA 165 x 165, 110 x 110 x 165 |
| Pz03 |  |  | PÓŁKA NAROŻNA OSTRĄ 165 x 165, 110 x 110 x 165 |
| Pz04 |  |  | PÓŁKA NAROŻNA ŁAMANA 165 x 165, 110 x 110 x 165 |

Pz01

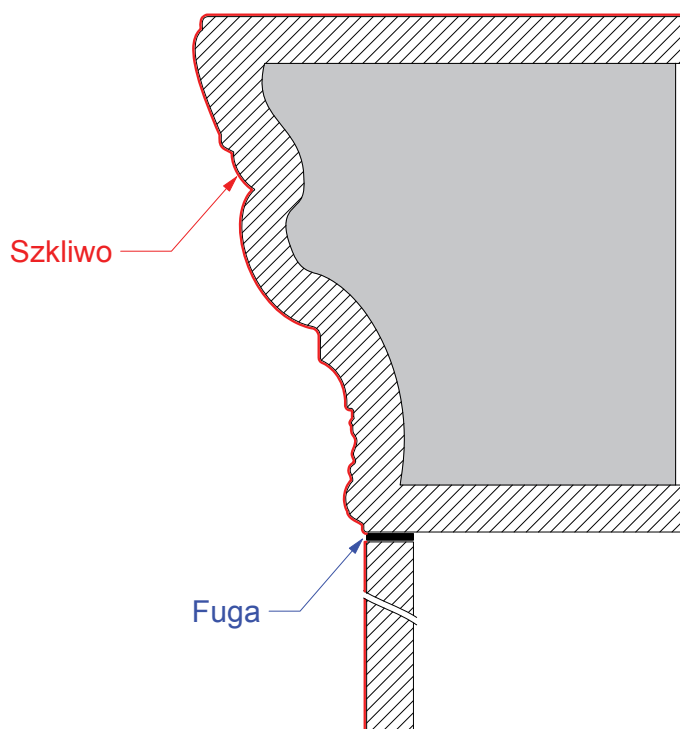





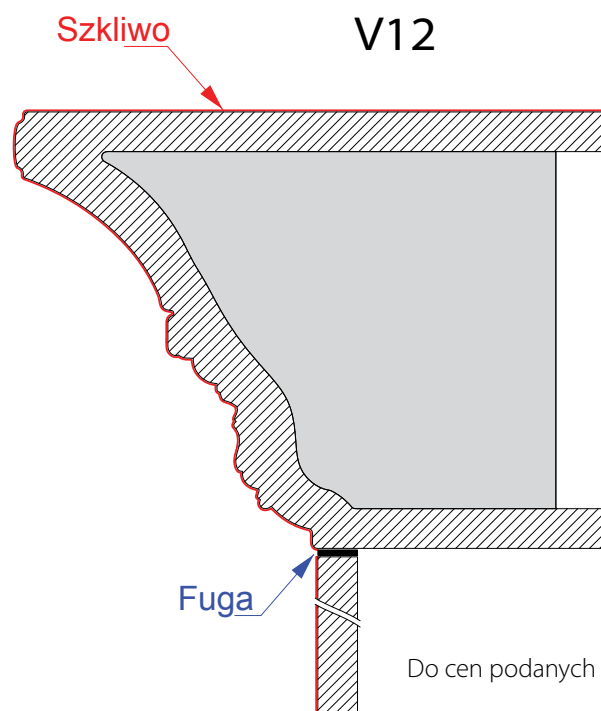











KAFLE PÓŁKI „VINTAGE”





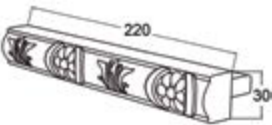

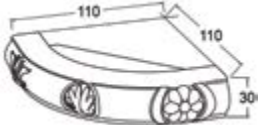

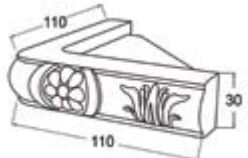

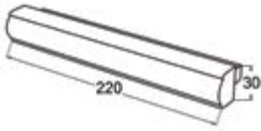

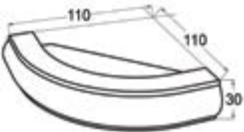
| Symbol | Fotografia | Rysunek (wymiary w mm) | Pełna nazwa (wymiary w mm) |
|--------|------------|---------------------------|---|
| V12 | | | PÓŁKA ŚRODKOWA 220 x 165 x 220 |
| V13 | | | PÓŁKA ROGOWA ZAKRĄGLONA 220 x 220, 110 x 110 x 165 |
| V14 | | | PÓŁKA ROGOWA OSTRĄ 220 x 220, 110 x 110 x 165 |
| V15 | | | PÓŁKA ROGOWA ŁAMANA 220 x 220, 110 x 110 x 165 |
| V16 | | | NOWOŚĆ! PÓŁKA ROGOWA 135° 220 x 220, 110 x 110 x 165 |

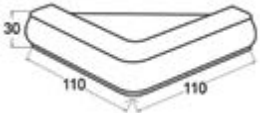

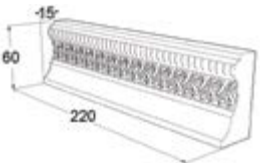
Tolerancja w wymiarach kafli max +/- 0,5%
Do cen podanych w tabeli należy doliczyć +23% (podatek VAT)

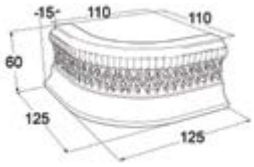
LISTWY DYSTANSOWE

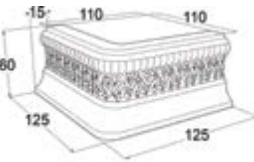
| Symbol | Fotografia | Rysunek (wymiary w mm) | Pełna nazwa (wymiary w mm) |
|--------|---|---|---|
| Ld01 |  |  | LISTWA DYSTANSOWA ŚRODKOWA „DECO” 220 x 60 |
| Ld02 |  |  | LISTWA DYSTANSOWA NAROŻNA ZAKRĄGLONA „DECO” 110 x 110 x 60 |
| Ld03 |  |  | LISTWA DYSTANSOWA NAROŻNA OSTRA „DECO” 110 x 110 x 60 |
| Ld04 |  |  | LISTWA DYSTANSOWA ŚRODKOWA „FAUN” 220 x 60 |
| Ld05 |  |  | LISTWA DYSTANSOWA NAROŻNA ZAKRĄGLONA „FAUN” 110 x 110 x 60 |
| Ld06 |  |  | LISTWA DYSTANSOWA NAROŻNA OSTRA „FAUN” 110 x 110 x 60 |
| Ld07 |  |  | LISTWA DYSTANSOWA ŚRODKOWA „3” 220 x 30 |
| Ld08 |  |  | LISTWA DYSTANSOWA NAROŻNA ZAKRĄGLONA „3” 110 x 110 x 30 |
| Ld09 |  |  | LISTWA DYSTANSOWA NAROŻNA OSTRA „3” 110 x 110 x 30 |

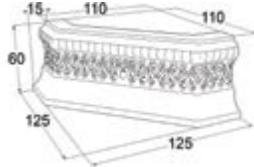
| | | | |
|------|---|---|--|
| Ld10 |  |  | LISTWA DYSTANSOWA ŚRODKOWA GŁADKA „3” 220 x 30 |
| Ld11 |  |  | LISTWA DYSTANSOWA NAROŻNA ZAKRĄGLONA GŁADKA „3” 110 x 110 x 30 |
| Ld12 |  |  | LISTWA DYSTANSOWA NAROŻNA OSTRA GŁADKA „3” 110 x 110 x 30 |
| Ld13 |  |  | LISTWA DYSTANSOWA ŚRODKOWA „VINTAGE” 220 x 60 |
| Ld14 |  |  | LISTWA DYSTANSOWA NAROŻNA ZAKRĄGLONA „VINTAGE” 110 x 110 x 60 |
| Ld15 |  |  | LISTWA DYSTANSOWA NAROŻNA OSTRA „VINTAGE” 110 x 110 x 60 |
| Ld16 |  |  | LISTWA DYSTANSOWA NAROŻNA ŁAMANA „VINTAGE” 110 x 110 x 60 |

Ld13

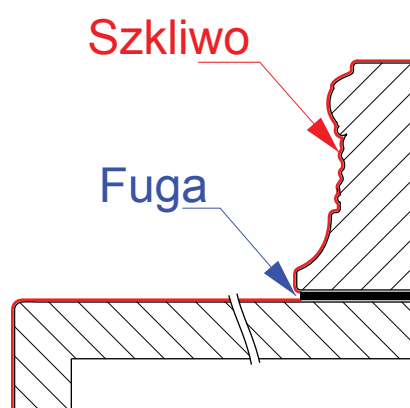



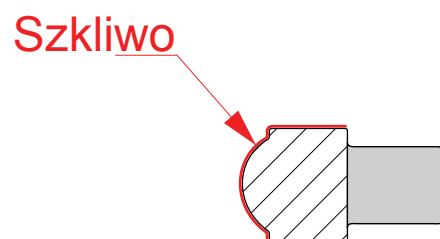



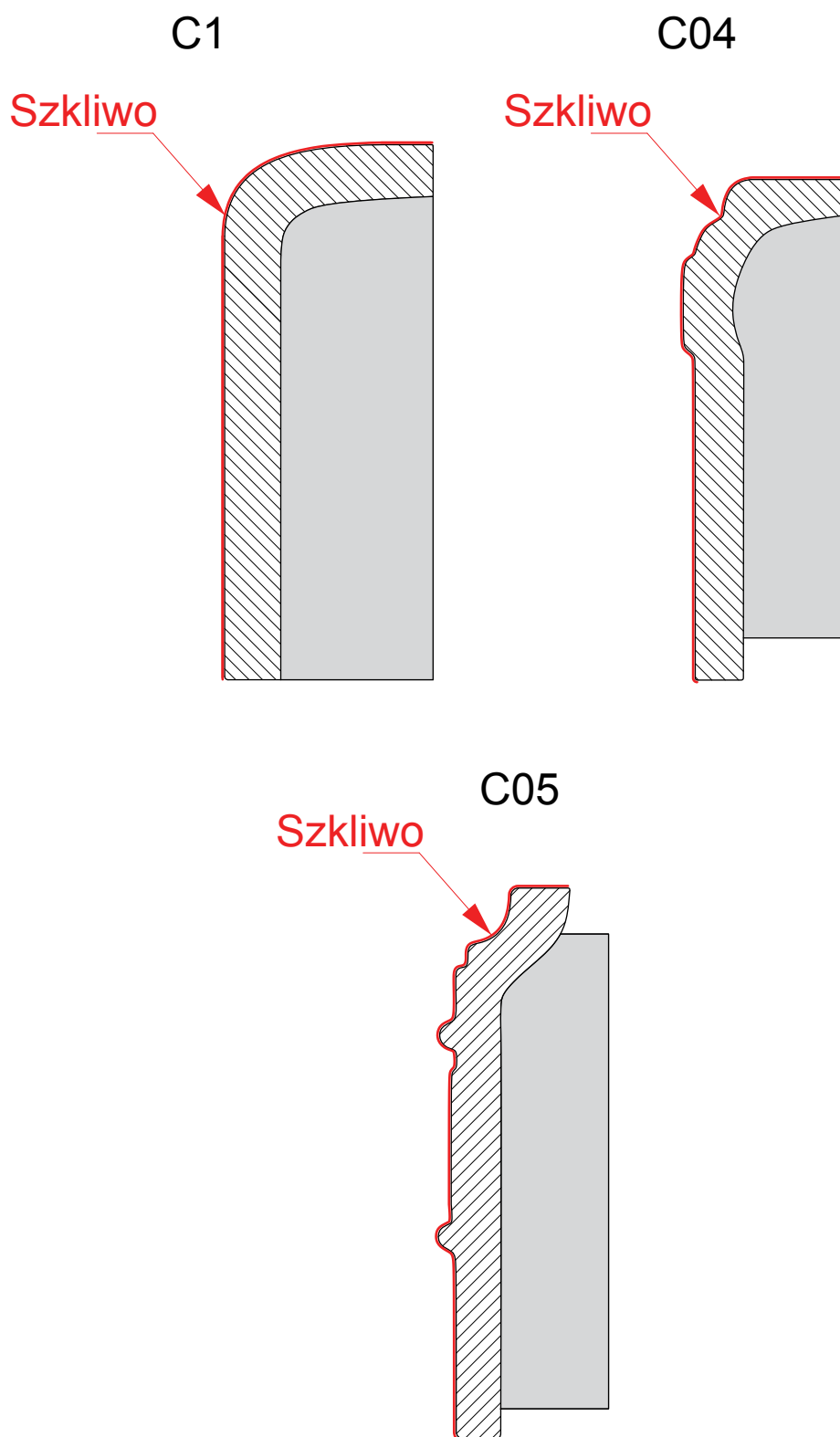



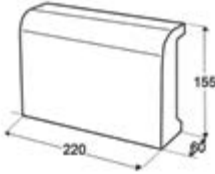

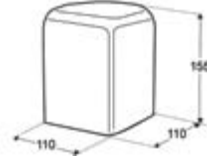

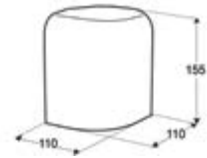

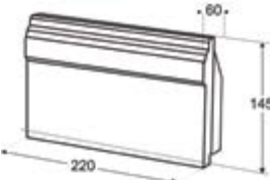
Ld07, Ld10

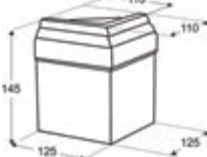



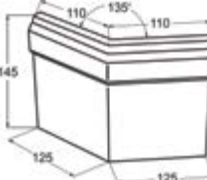

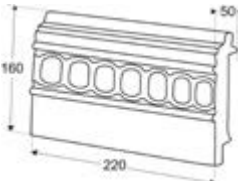

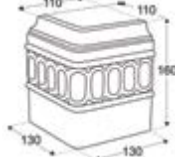

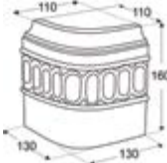

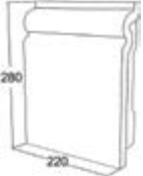

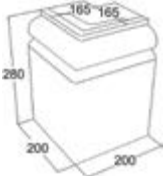

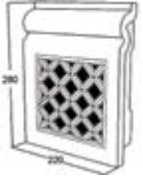

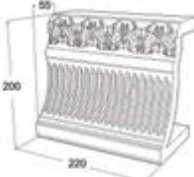

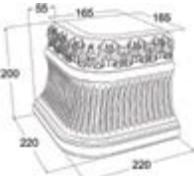
Tolerancja w wymiarach kafli max +/- 0,5%
Do cen podanych w tabeli należy doliczyć +23% (podatek VAT)

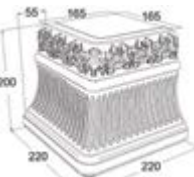

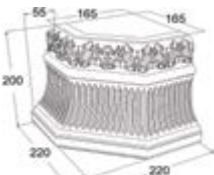

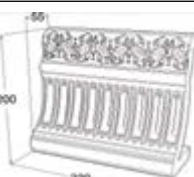



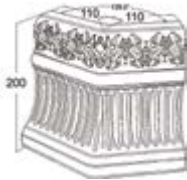

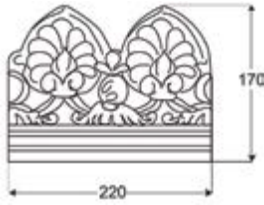

COKOŁY

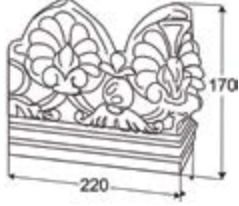
| Symbol | Fotografia | Rysunek (wymiary w mm) | Pełna nazwa (wymiary w mm) |
|--------|---|---|---|
| C01 |  |  | COKÓŁ ŚRODKOWY „PROSTY” 220 x 155 x 60 |
| C02 |  |  | COKÓŁ NAROŻNY OSTRY „PROSTY” 110 x 110 x 155 |
| C07 |  |  | COKÓŁ NAROŻNY ZAKRĄGLONY „PROSTY” 110 x 110 x 155 |
| C03 |  |  | COKÓŁ ŚRODKOWY „PROFIL” 220 x 145 x 60 |
| C04 |  |  | COKÓŁ NAROŻNY OSTRY „PROFIL” 110 x 110 x 145, 125 x 125 |
| C08 |  |  | COKÓŁ NAROŻNY ZAKRĄGLONY „PROFIL” 110 x 110 x 145, 125 x 125 |
| C13 |  |  | COKÓŁ NAROŻNY ROZWARTY „PROFIL” 135° 110 x 110 x 145, 125 x 125 |
| C05 |  |  | COKÓŁ ŚRODKOWY „OKNA” 220 x 160 x 50 |
| C06 |  |  | COKÓŁ NAROŻNY OSTRY „OKNA” 110 x 110 x 160, 130 x 130 |

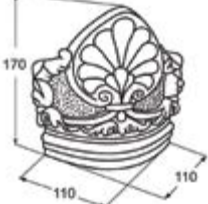



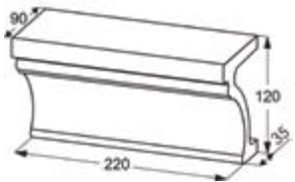

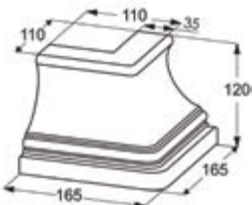

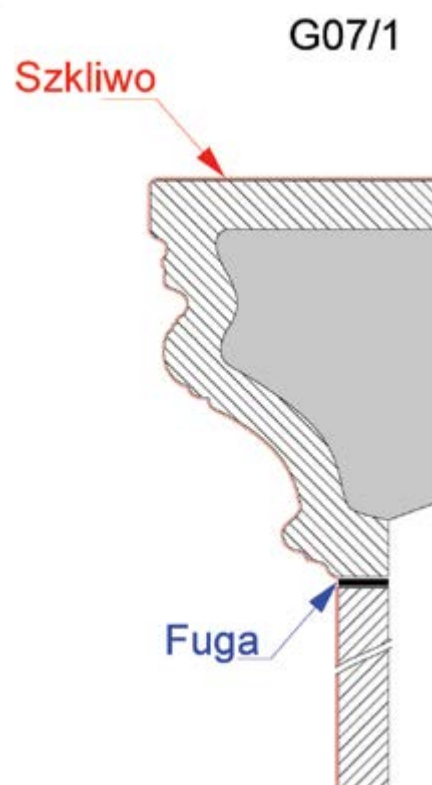
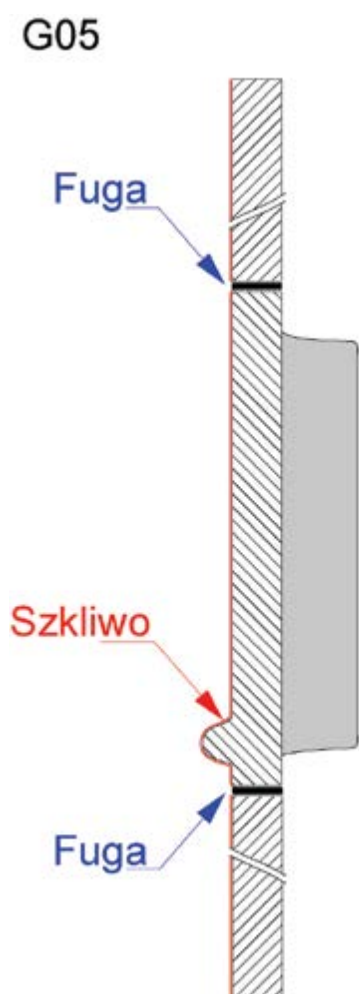
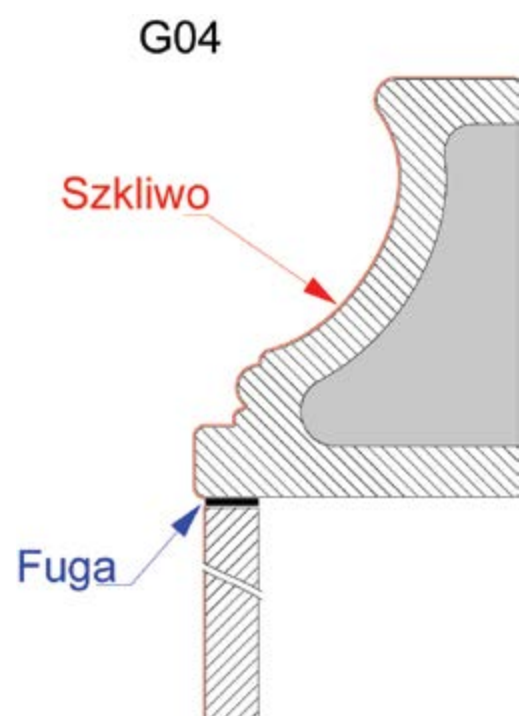

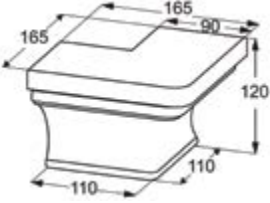

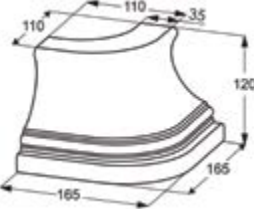

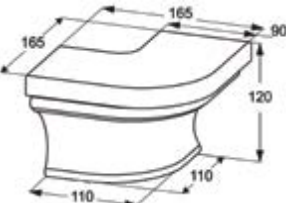
| Symbol | Fotografia | Rysunek (wymiały w mm) | Pełna nazwa (wymiały w mm) |
|--------|---|---|--|
| C09 |  |  | COKÓŁ NAROŻNY ZAKRĄGLONY „OKNA” 110 x 110 x 160, 130 x 130 |
| C10 |  |  | COKÓŁ ŚRODKOWY „DWORSKIE” 220 x 280 |
| C11 |  |  | COKÓŁ NAROŻNY OSTRY „DWORSKIE” 200 x 200 x 280, 165 x 165 |
| C12 |  |  | COKÓŁ ŚRODKOWY Z WYWIETRZNIKIEM „DWORSKIE” 220 x 280 x 70 |
| C14 |  |  | COKÓŁ ŚRODKOWY „VINTAGE” 220 x 200 x 90 |
| C15 |  |  | COKÓŁ NAROŻNY ZAKRĄGLONY „VINTAGE” 220 x 220 x 200, 165 x 165 |
| C16 |  |  | COKÓŁ NAROŻNY OSTRY „VINTAGE” 220 x 220 x 200, 165 x 165 |
| C17 |  |  | COKÓŁ NAROŻNY ŁAMANY „VINTAGE” 220 x 220 x 200, 165 x 165 |
| C18 |  |  | COKÓŁ ŚRODKOWY Z WYWIETRZNIKIEM „VINTAGE” 220 x 200 x 90 |

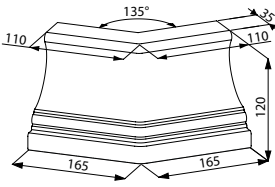
| | | | |
|-----|---|---|---|
| C19 |  |  | COKÓŁ ŚRODKOWY „VINTAGE” 135° 110 x 110 x 200 |
|-----|---|---|---|

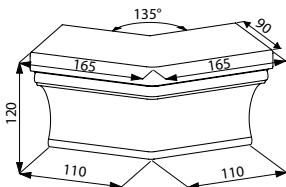

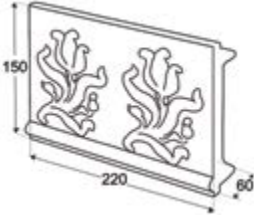
GZYMSY

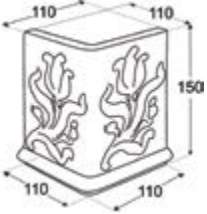
| Symbol | Fotografia | Rysunek (wymiary w mm) | Pełna nazwa (wymiary w mm) |
|--------|---|---|--|
| G01 |  |  | GZYMS OZDOBNY ŚRODKOWY „KORONA” 220 x 170 |
| G02 |  |  | GZYMS OZDOBNY NAROŻNY OSTRY „KORONA” 165 x 55 x 170 |
| G23 |  |  | GZYMS NAROŻNY ŁAGODNY „KORONA” 170 x 110 x 110 |
| G03 |  |  | GZYMS ŚRODKOWY „NISKI” 220 x 120 x 90 |
| G03/1 |  |  | GZYMS ŚRODKOWY „NISKI” 90 x 120 x 220 |
| G04 |  |  | GZYMS NAROŻNY OSTRY „NISKI” 110 x 110 x 120, 165 x 165 |

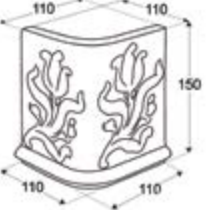

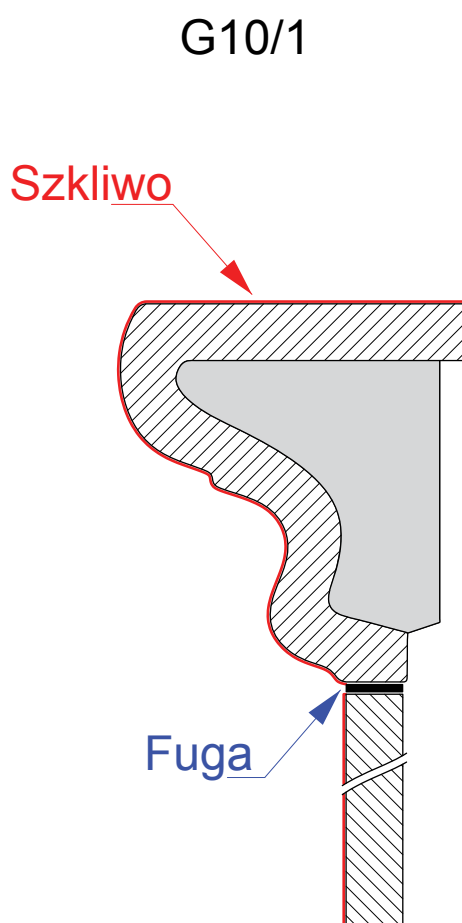
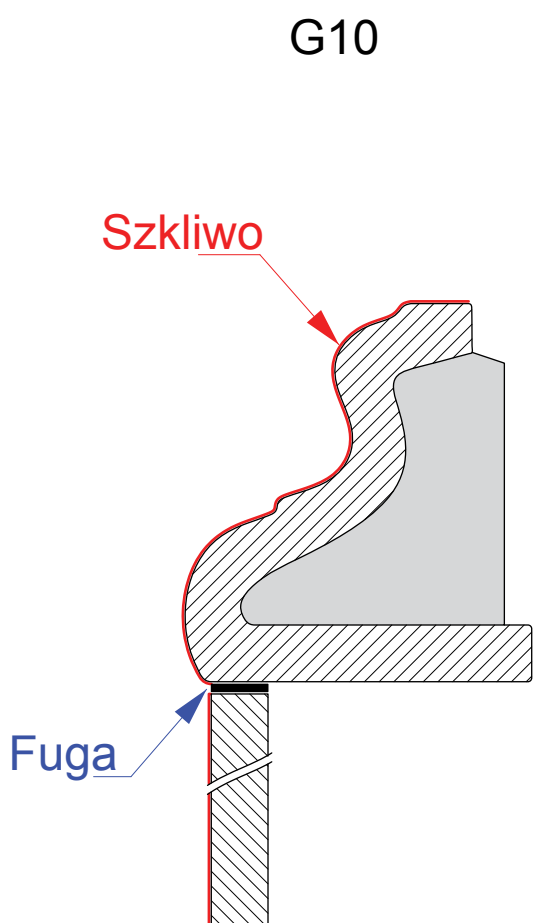







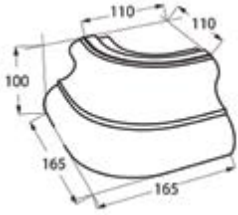

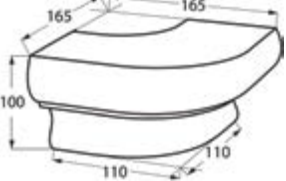

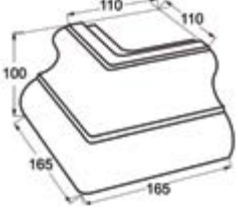

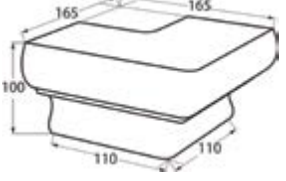

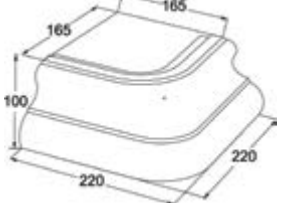

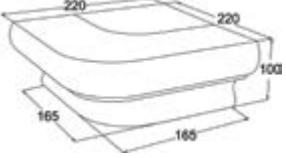
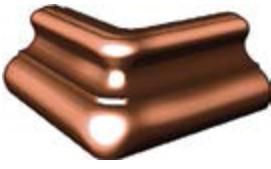
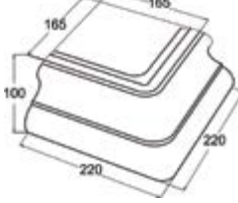

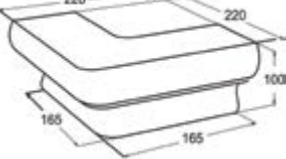



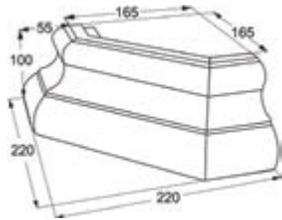

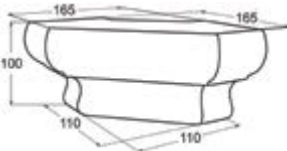

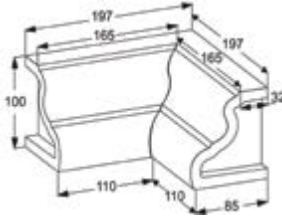
| Symbol | Fotografia | Rysunek (wymiary w mm) | Pełna nazwa (wymiary w mm) |
|--------|---|---|---|
| G04/1 |  |  | GZYMS NAROŻNY OSTRY „NISKI” 165 x 165, 110 x 110 x 120 |
| G17 |  |  | GZYMS NAROŻNY ZAKRĄGLONY „NISKI” 110 x 110 x 120, 165 x 165 |
| G17/1 |  |  | GZYMS NAROŻNY ZAKRĄGLONY „NISKI” 165 x 165, 110 x 110 x 120 |
| G24 |  |  | GZYMS NAROŻNY „NISKI” 135° 110 x 110 x 120, 165 x 165 |
| G24/1 |  |  | GZYMS NAROŻNY „NISKI” 135° 165 x 165, 110 x 110 x 120 |
| G05 |  |  | GZYMS ŚRODKOWY „MAKI” 220 x 150 x 60 |
| G06 |  |  | GZYMS NAROŻNY OSTRY „MAKI” 110 x 110 x 150 |
| G13 |  |  | GZYMS NAROŻNY ZAKRĄGLONY „MAKI” 110 x 110 x 150 |

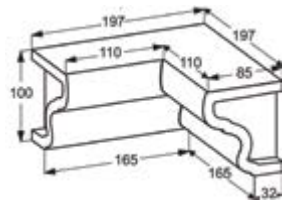

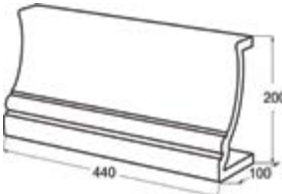

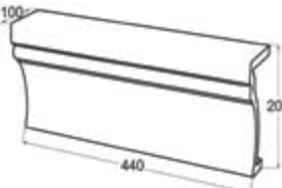



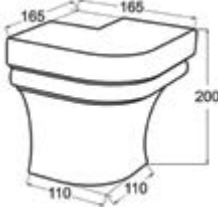

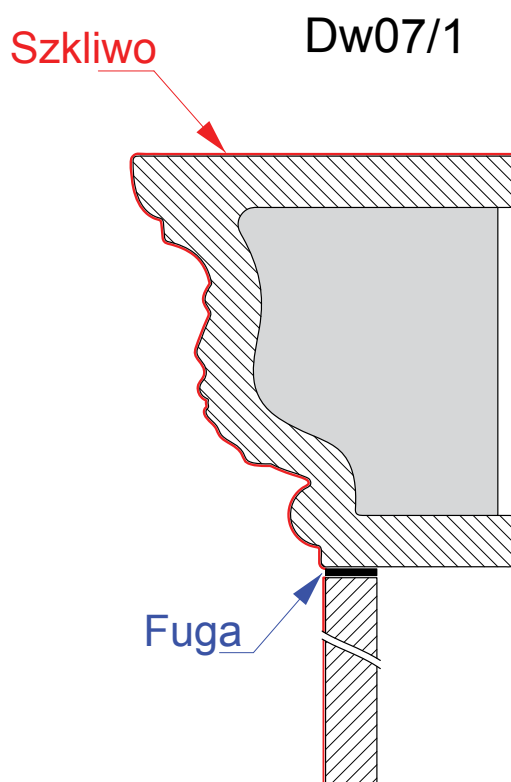
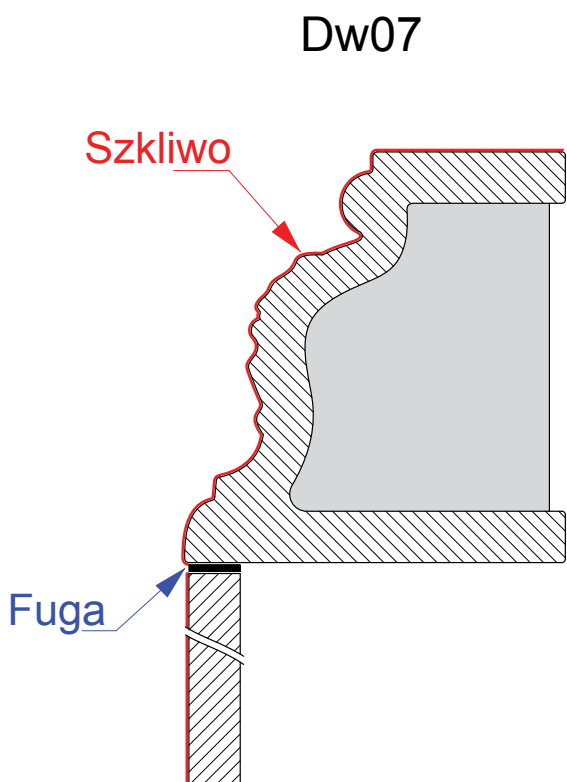
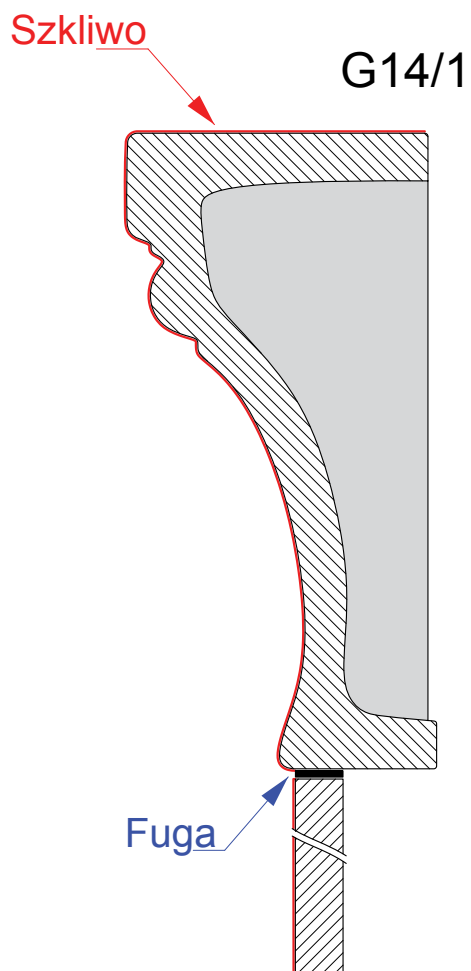
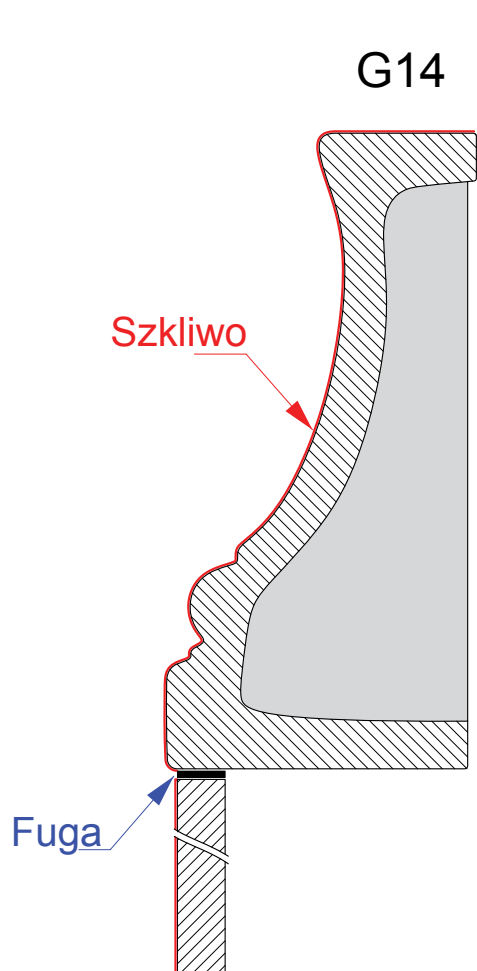



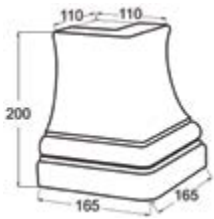

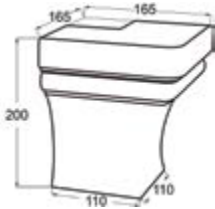

| Symbol | Fotografia | Rysunek (wymiary w mm) | Pełna nazwa (wymiary w mm) |
|--------|---|---|--|
| G07 |  |  | GZYMS ŚRODKOWY „LISTKI” 220 x 120 x 85 |
| G07/1 |  |  | GZYMS ŚRODKOWY „LISTKI” 220 x 120 x 85 |
| G08 |  |  | GZYMS NAROŻNY OSTRY „LISTKI” 110 x 110 x 120, 165 x 165 |
| G08/1 |  |  | GZYMS NAROŻNY OSTRY „LISTKI” 165 x 165, 110 x 110 x 120 |
| G09 |  |  | GZYMS NAROŻNY ZAKRĄGLONY „LISTKI” 110 x 110 x 120, 165 x 165 |
| G09/1 |  |  | GZYMS NAROŻNY ZAKRĄGLONY „LISTKI” 165 x 165, 110 x 110 x 120 |
| G10 |  |  | GZYMS ŚRODKOWY „OWAL” 220 x 100 x 85 |
| G10/1 |  |  | GZYMS ŚRODKOWY „OWAL” 220 x 100 x 85 |

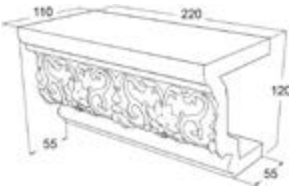
Tolerancja w wymiarach kafli max +/- 0,5%
Do cen podanych w tabeli należy doliczyć +23% (podatek VAT)

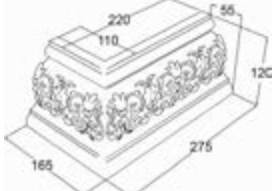
| Symbol | Fotografia | Rysunek (wymiary w mm) | Pełna nazwa (wymiary w mm) |
|--------|---|---|--|
| G11 |  |  | GZYMS NAROŻNY ZAKRĄGLONY „OWAL” 110 x 110 x 100, 165 x 165 |
| G11/1 |  |  | GZYMS NAROŻNY ZAKRĄGLONY „OWAL” 165 x 165, 110 x 110 x 100 |
| G12 |  |  | GZYMS NAROŻNY „OWAL” 110 x 110 x 100, 165 x 165 |
| G12/1 |  |  | GZYMS NAROŻNY „OWAL” 165 x 165, 110 x 110 x 100 |
| G18 |  |  | GZYMS NAROŻNY ZAKRĄGLONY „OWAL” 165 x 165 x 100, 220 x 220 |
| G18/1 |  |  | GZYMS NAROŻNY ZAKRĄGLONY „OWAL” 220 x 220, 165 x 165 x 100 |
| G19 |  |  | GZYMS NAROŻNY OSTRY „OWAL” 165 x 165 x 100, 220 x 220 |
| G19/1 |  |  | GZYMS NAROŻNY OSTRY „OWAL” 220 x 220, 165 x 165 x 100 |

| | | | |
|-------|---|---|---|
| G20 |  |  | GZYMS NAROŻNY PODCOKOLNIK „OWAŁ” 165 x 165 x 100, 220 x 220 |
| G21 |  |  | GZYMS NAROŻNY ŁAMANY „OWAŁ” 165 x 165, 110 x 110 x 100 |
| G22 |  |  | GZYMS NAROŻNY WEWNĘTRZNY „OWAŁ” 165 x 165 x 100, 110 x 110 |
| G22/1 |  |  | GZYMS NAROŻNY WEWNĘTRZNY „OWAŁ” 110 x 110, 165 x 165 x 100 |
| G14 |  |  | GZYMS ŚRODKOWY „WYSOKI” 440 x 200 x 100 |
| G14/1 |  |  | GZYMS ŚRODKOWY „WYSOKI” 440 x 200 x 100 |
| G15 |  |  | GZYMS NAROŻNY ZAKRĄGLONY „WYSOKI” 110 x 110 x 200, 165 x 165 |
| G15/1 |  |  | GZYMS NAROŻNY ZAKRĄGLONY „WYSOKI” 165 x 165, 110 x 110 x 200 |

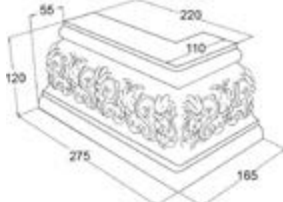

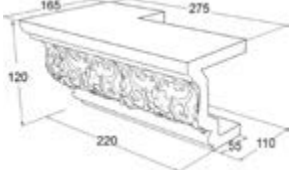
| Symbol | Fotografia | Rysunek (wymiary w mm) | Pełna nazwa (wymiary w mm) |
|---------|---|---|--|
| G16 |  |  | GZYMS NAROŻNY OSTRY „WYSOKI” 110 x 110 x 200, 165 x 165 |
| G16/1 |  |  | GZYMS NAROŻNY OSTRY „WYSOKI” 165 x 165, 110 x 110 x 200 |
| Dw07 |  |  | GZYMS ŚRODKOWY 220 x 120 x 110 |
| Dw07/1 |  |  | GZYMS ŚRODKOWY 220 x 120 x 110 |
| Dw09L |  |  | GZYMS NAROŻNY OSTRY 220 x 110 x 120, 275 x 165 Uwaga R-2 |
| Dw09L/1 |  |  | GZYMS NAROŻNY OSTRY 275 x 165, 220 x 110 x 120 Uwaga R-2 |
| Dw09P |  |  | GZYMS NAROŻNY OSTRY 220 x 110 x 120, 275 x 165 Uwaga R-2 |
| Dw09P/1 |  |  | GZYMS NAROŻNY OSTRY 275 x 165, 220 x 110 x 120 Uwaga R-2 |

Element Kz08 Korona Duża "NENUFARY"
660 x 340 (880 x 340 x 110 z narożnikami)





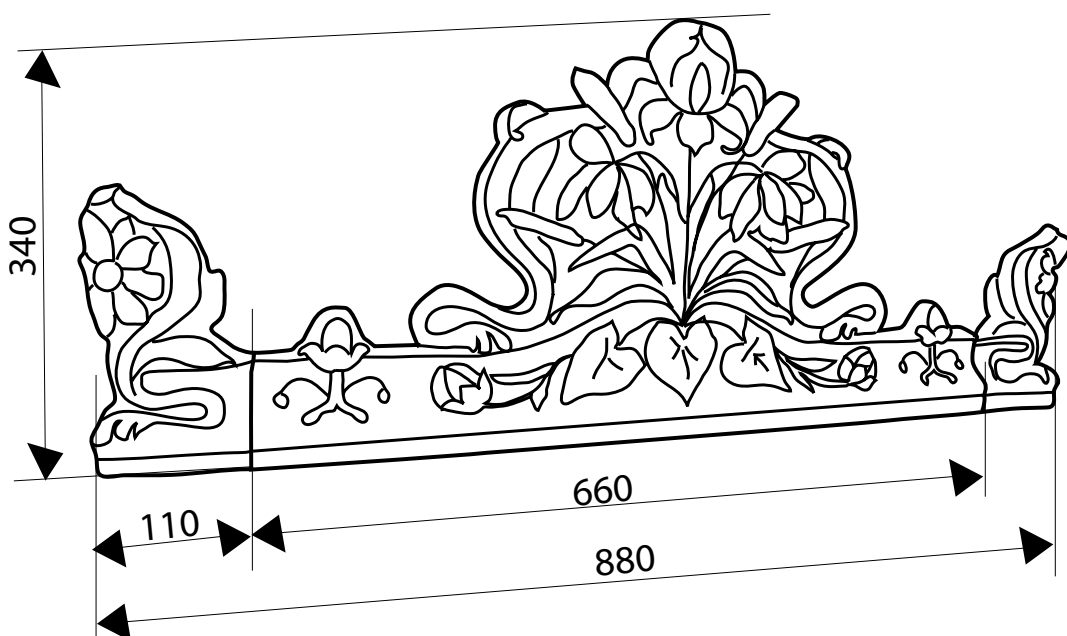



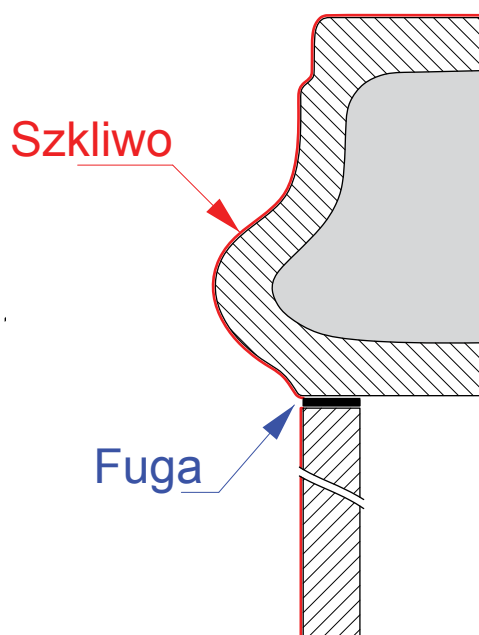

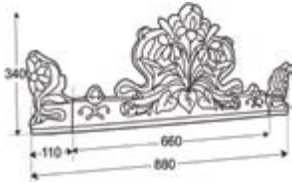

Kz08

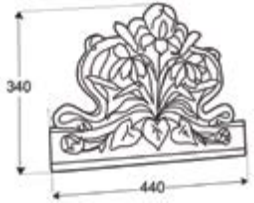

L02

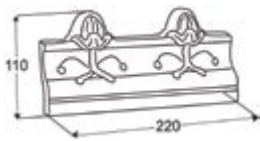

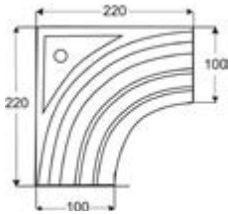

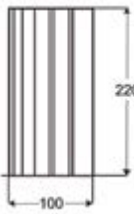



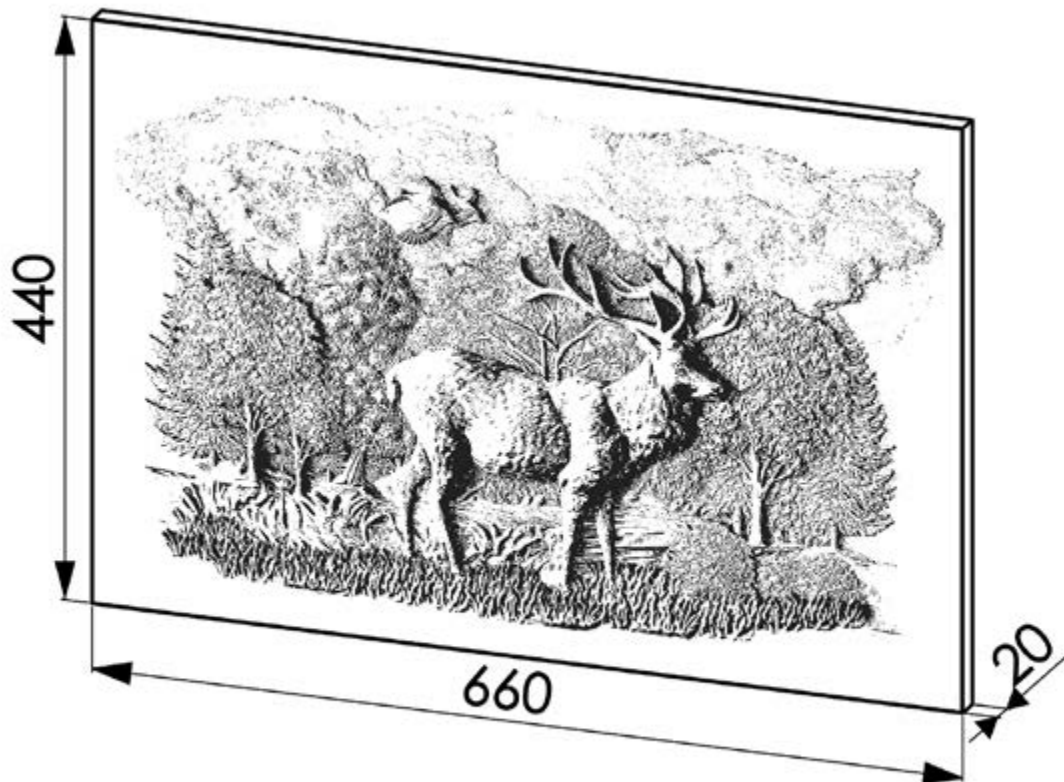

KAFLE WYKOŃCZENIOWE, DEKORACYJNE



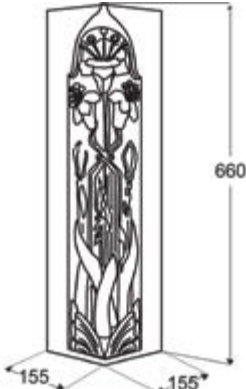







| Symbol | Fotografia | Rysunek (wymiary w mm) | Pełna nazwa (wymiary w mm) |
|--------|---|---|--|
| Kz08 |  |  | KORONA DUŻA „NENUFARY” 660 x 340, (880 x 340 x 110 Z NAROŻNIKAMI) |
| Kz09 |  |  | KORONA MAŁA „NENUFARY” 440 x 340 |
| Kz10 |  |  | NAROŻNIK „NENUFARY” 110 x 110 x 210 |
| Kz11 |  |  | ELEMENT MODUŁOWY WYPEŁNIAJĄCY „NENUFARY” 220 x 110 |
| L01 |  |  | KAFEL ŁUK NAROŻNY 220 x 220 x 100 |
| L02 |  |  | KAFEL ŁUK ŚRODKOWY 220 x 100 |

Kafel ozdobny „JELEŃ” 660 x 660 x 20 (Kafel bez rompy)

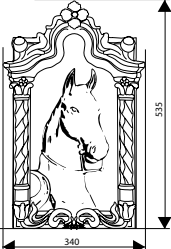
L11





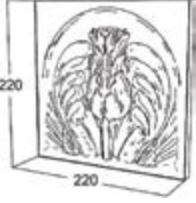



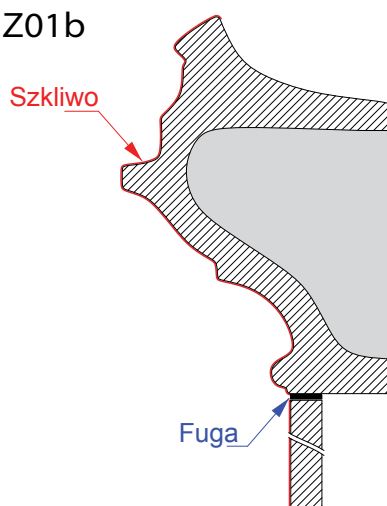



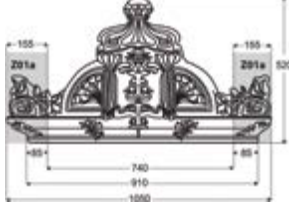

| Symbol | Fotografia | Rysunek (wymiary w mm) | Pełna nazwa (wymiary w mm) |
|--------|---|---|---|
| L03 |  |  | ELEMENT OZDOBNY NAROŻNIK DUŻY „KOLUMNA” 660 x 155 x 155 |
| L09 |  |  | ELEMENT OZDOBNY NAROŻNIK DUŻY „KOLUMNA VINTAGE ” 665 x 165 x 165 |
| L10 |  |  | ELEMENT OZDOBNY NAROŻNIK DUŻY „KOLUMNA OGAREK ” 665 x 165 x 165 |
| L11 |  |  | KAFEL OZDOBNY „JELEŃ” 660 x 440 x 20 (kafel bez rompy) |

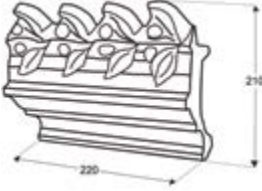
| Symbol | Fotografia | Rysunek (wymiary w mm) | Pełna nazwa (wymiary w mm) |
|--------|---|---|---|
| L04 |  |  | ELEMENT OZDOBNY „DWOREK” 660 x 440 x 25 |
| L05 |  |  | ELEMENT OZDOBNY „OSTY” 530 x 335 x 55 |
| L12 |  |  | ELEMENT OZDOBNY „KOŃ” 535 x 340 x 75 |
| L06 |  |  | POSTUMENT 134 x 134 x 200, 78 x 78 (podstawa) |
| L07 |  |  | POSTUMENT OWALNY 120 x wys. 70, kryza 60 |
| L08 |  |  | KAFEL OZDOBNY „OSTY” 220 x 220 x 50 |

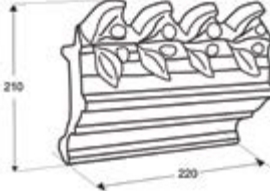
Z01b

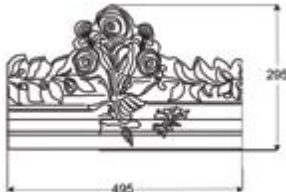

KAFLE „SECESJA”

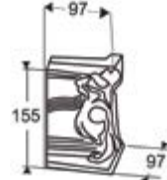
| Symbol | Fotografia | Rysunek (wymiary w mm) | Pełna nazwa (wymiary w mm) |
|--------|---|---|---|
| Z01 |  |  | KORONA DUŻA Z NAROŻNIKAMI 910 x 520 x 85 |
| Z01a |  |  | NAROŻNIK 85 x 85 x 240 |
| Z01bP |  |  | ELEMENT MODUŁOWY WYPEŁNIAJĄCY PRAWY 220 x 210 |
| Z01bL |  |  | ELEMENT MODUŁOWY WYPEŁNIAJĄCY LEWY 220 x 210 |
| Z02 |  |  | KORONA MAŁA 495 x 295 x 85 |
| Z03 |  |  | LISTWA ZDOBIONA Z NAROŻNIKAMI 910 x 155 x 97 |
| Z03a |  |  | NAROŻNIK 97 x 97 x 155 |

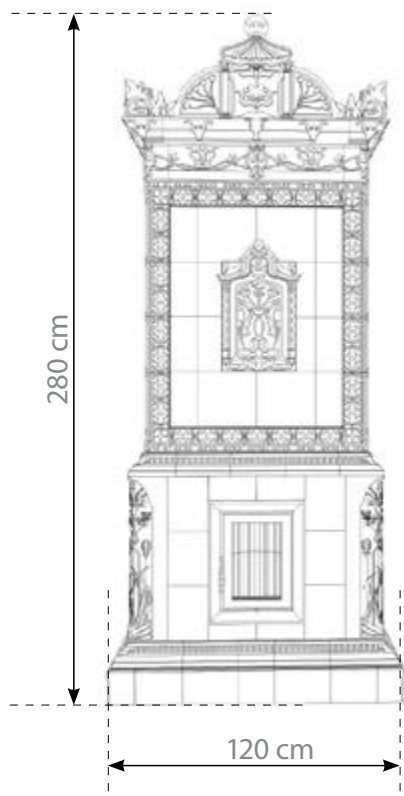

ver. 1

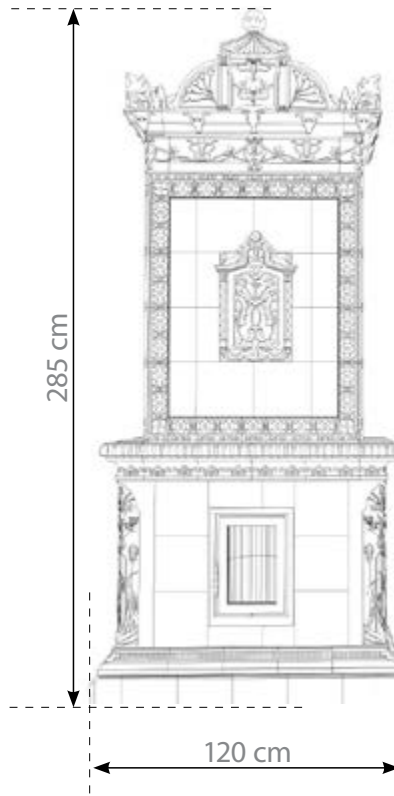







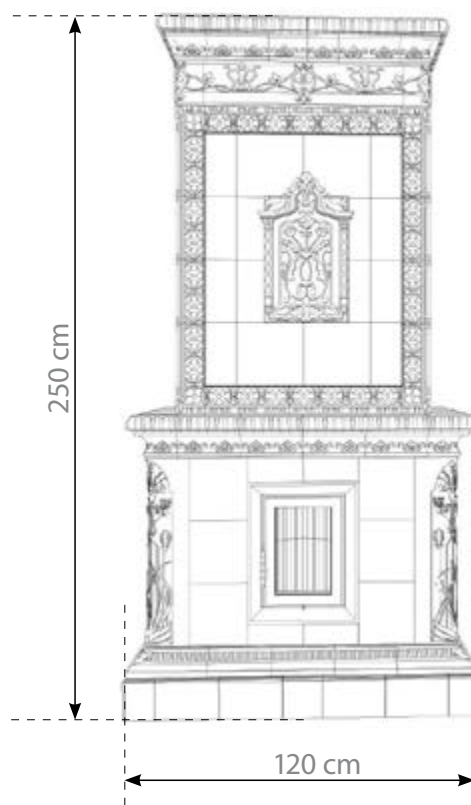





ver. 2

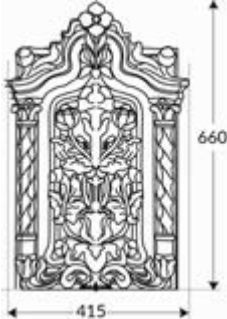

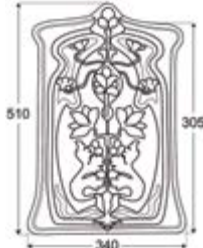
ver. 3

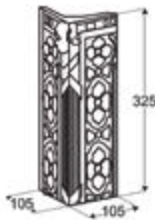

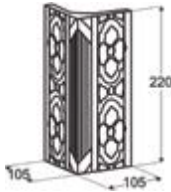

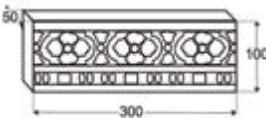





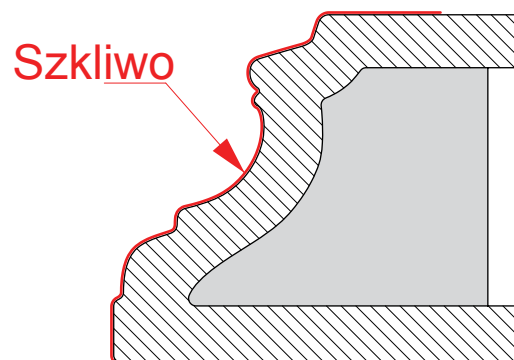



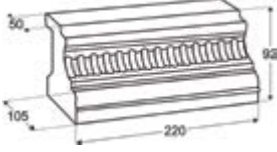

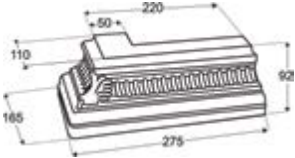
ver. 4

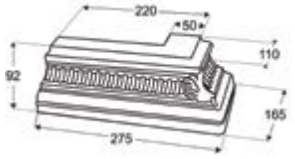
| Symbol | Fotografia | Rysunek (wymiary w mm) | Pełna nazwa (wymiary w mm) |
|--------|---|---|---|
| Z04 |  |  | LISTWA ZDOBIONA BEZ NAROŻNIKÓW 715 x 155 x 60 |
| Z05/1 |  |  | ELEMENT ZDOBIONY „MAKI 1” 535 x 340 x 75 |
| Z05/1D |  |  | ELEMENT ZDOBIONY „MAKI 1” DUŻY 660 x 415 x 75 |
| Z05/2 |  |  | ELEMENT ZDOBIONY „MAKI 2” 510 x 340 x 65 |
| Z06 |  |  | GZYMS ZDOBIONY NAROŻNY PIONOWY 325 x 105 x 105 |
| Z07 |  |  | GZYMS ZDOBIONY NAROŻNY / ŚRODKOWY WYPEŁNIAJĄCY 220 x 105 x 105 |
| Z08 |  |  | LISTWA ZDOBIONA ŚRODKOWA POZIOMA 300 x 100 x 50 |

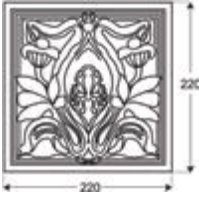

Z09

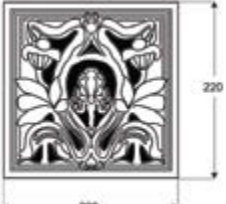

| Symbol | Fotografia | Rysunek (wymiary w mm) | Pełna nazwa (wymiary w mm) |
|--------|---|---|---|
| Z09 |  |  | GZYMS ŚRODKOWY „PRZEWĘŻENIE” 220 x 105 x 92 |
| Z10L |  |  | GZYMS NAROŻNY „PRZEWĘŻENIE” LEWY 220 x 110 x 92, 275 x 165 |
| Z10P |  |  | GZYMS NAROŻNY „PRZEWĘŻENIE” PRAWY 220 x 110 x 92, 275 x 165 |
| Z11 |  |  | KAFEL OZDOBNY ŚRODKOWY 220 x 220 x 50 |
| Z12 |  |  | KAFEL OZDOBNY NAROŻNY 220 x 110 x 110 |
| Z13 |  |  | KAFEL OZDOBNY POŁÓWKA 1/2 220 x 110 x 50 |
| Z14 |  |  | KAFEL OZDOBNY Z WYWIETRZNIKIEM 220 x 220 x 50 |

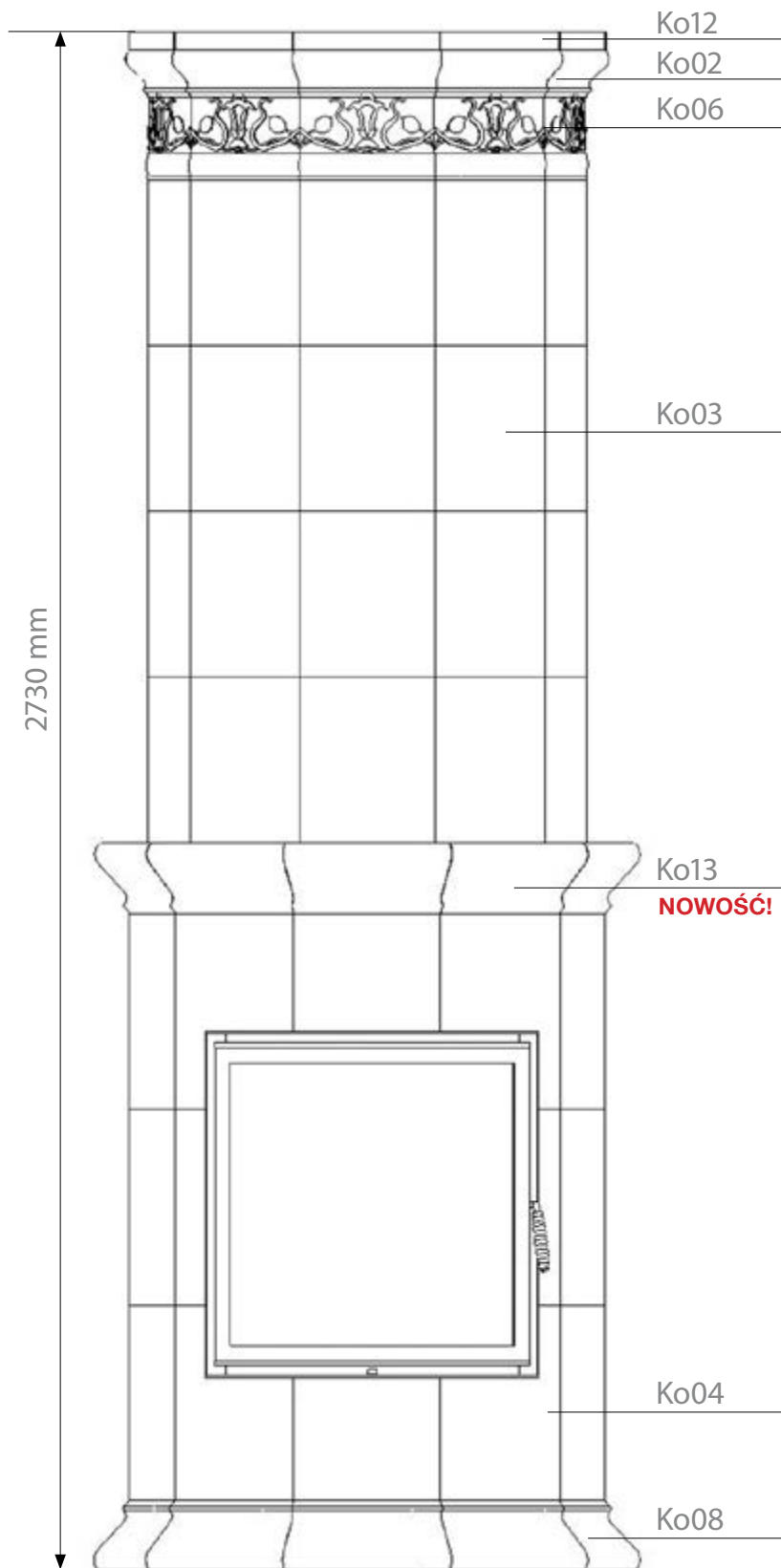



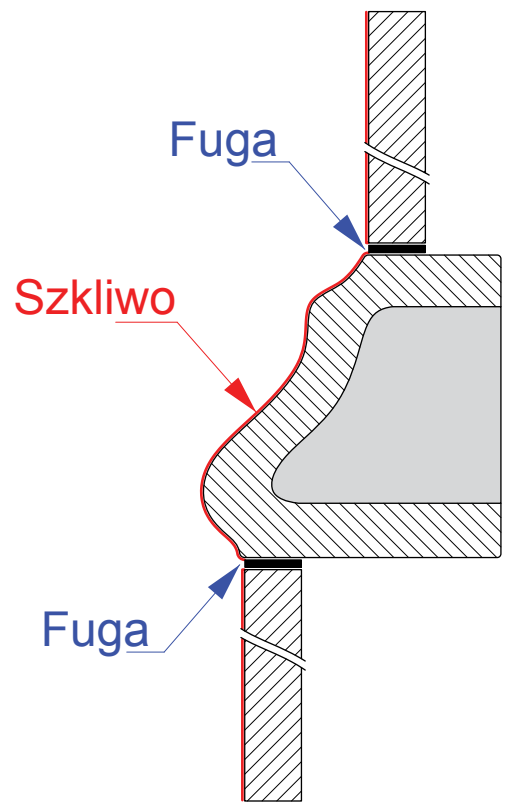



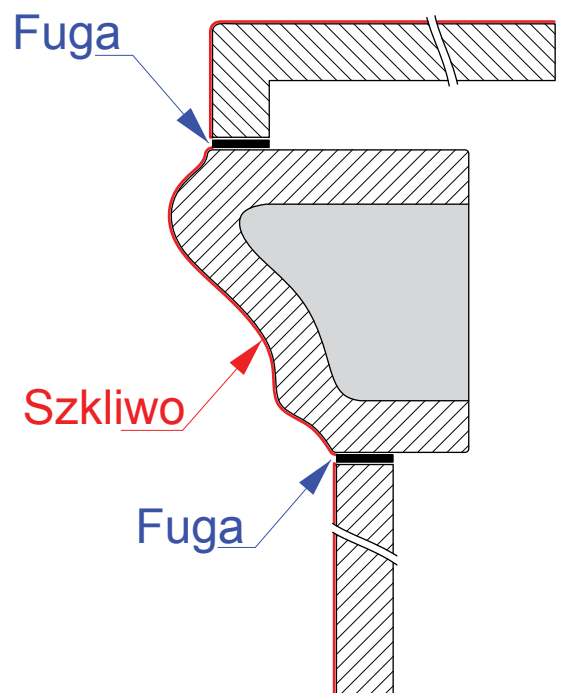



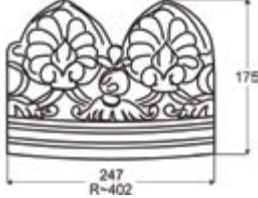

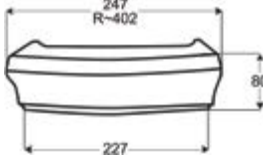
Ko02



Ko02/1

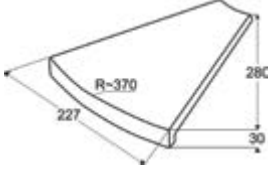

PIEC OKRĄGLY KLASYCZNY

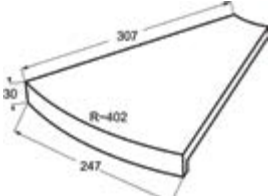

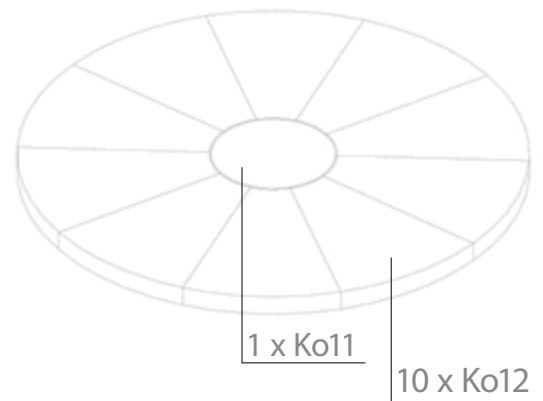
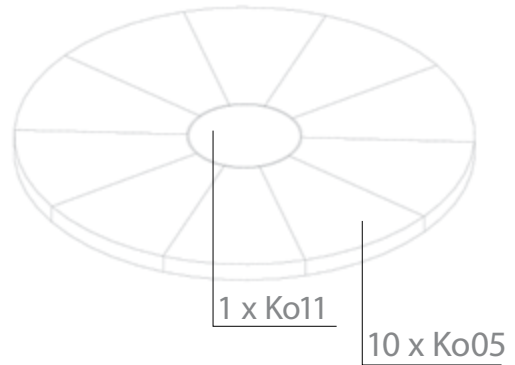
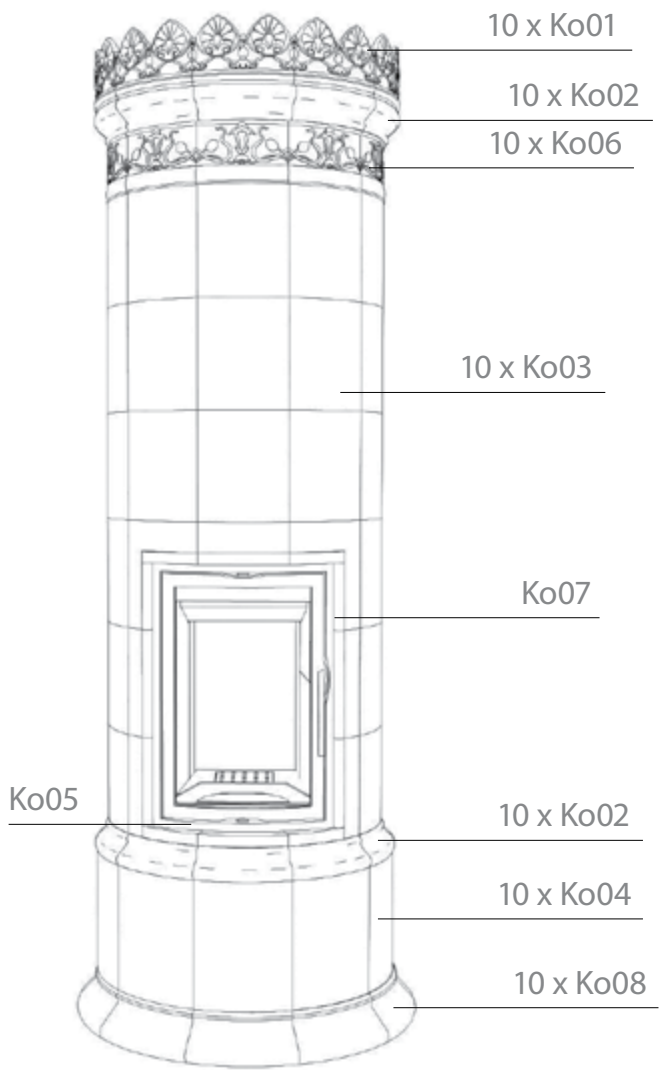





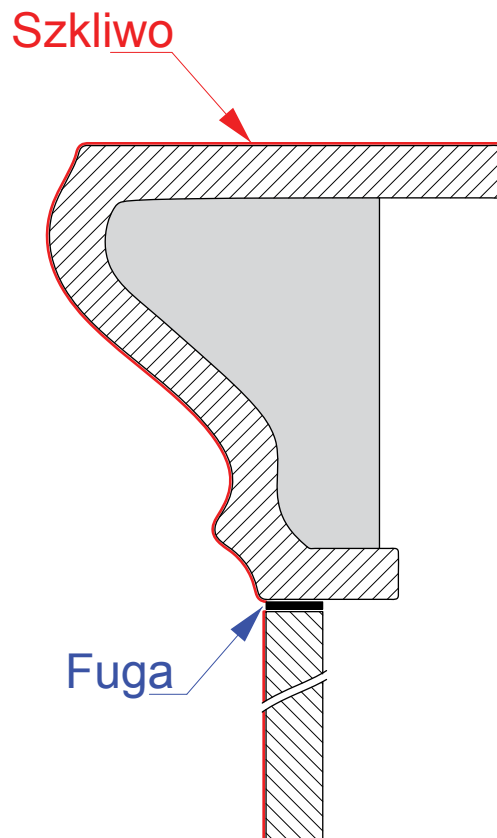
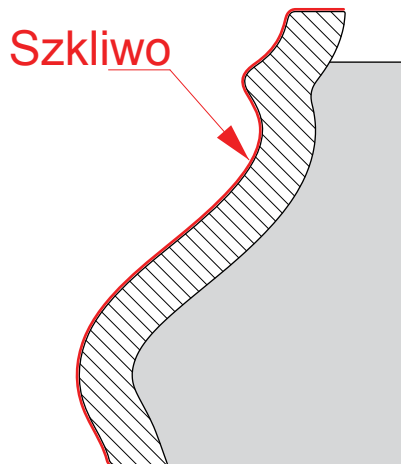

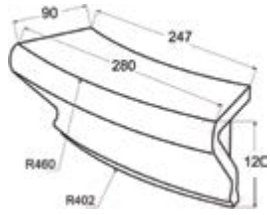

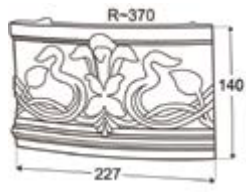
| Symbol | Fotografia | Rysunek (wymiary w mm) | Pełna nazwa (wymiary w mm) |
|--------|---|---|---|
| Ko01 |  |  | GZYMS 247 x 175, R ~402 |
| Ko02 |  |  | GZYMS PRZEWEŻENIE 247 x 227 x 80, R ~402 |
| Ko02/1 |  |  | GZYMS PRZEWEŻENIE 227 x 247 x 80, R ~370 |
| Ko03 |  |  | KAFEL ŚRODKOWY 280 x 227, R ~370 |
| Ko04 |  |  | KAFEL ŚRODKOWY 330 x 247, R ~402 |
| Ko05 |  |  | PÓŁKA 227 x 30, R ~370 |
| Ko12 |  |  | PÓŁKA 247 x 30, R ~402 |





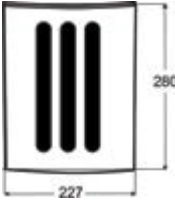



Ko08

Ko13

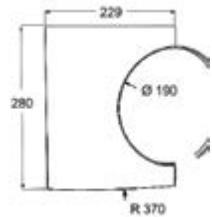

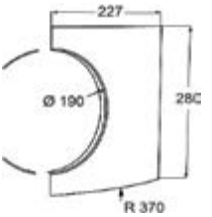

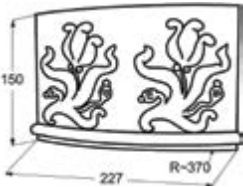

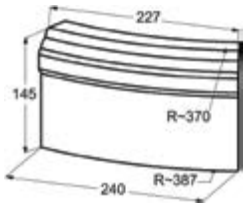

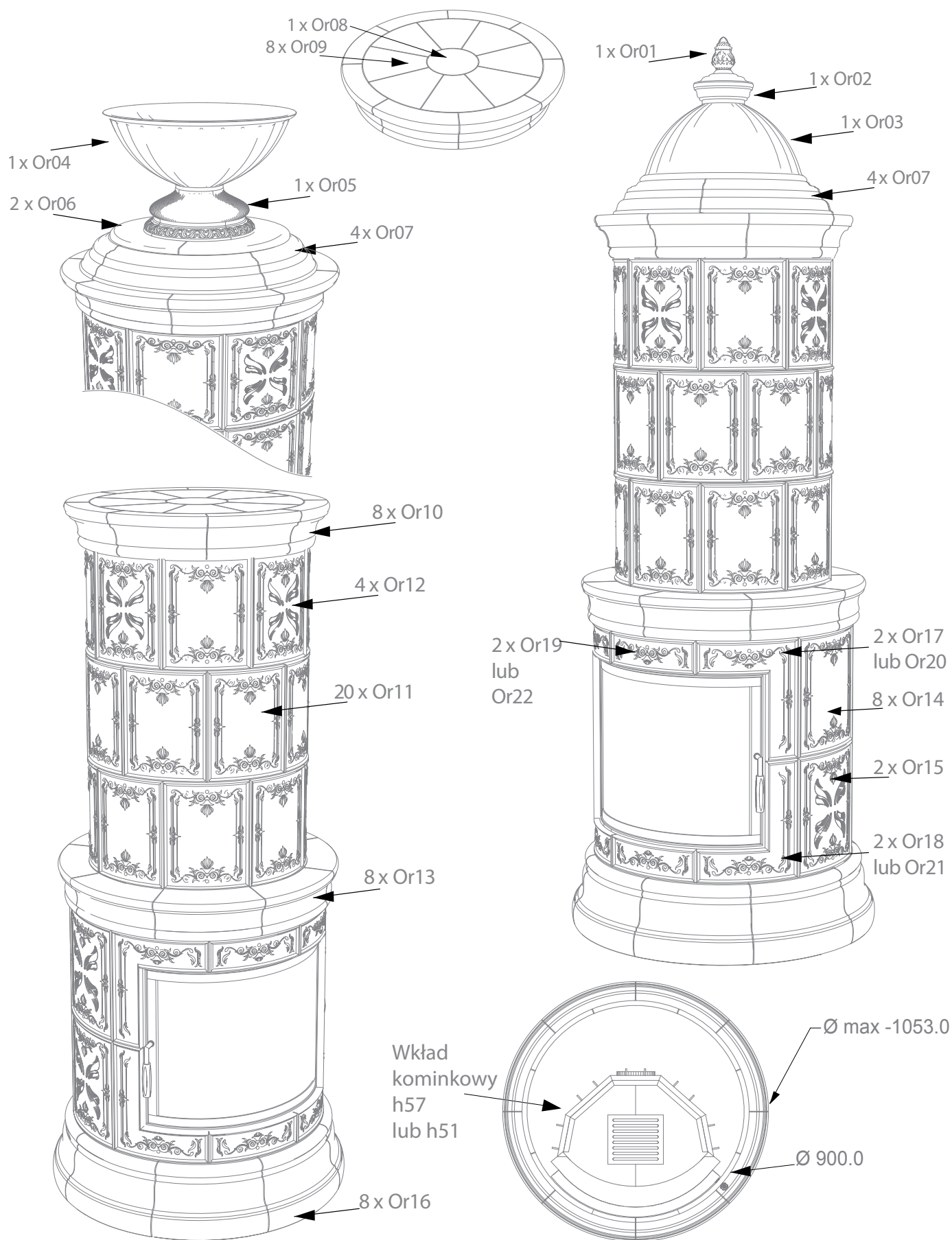





| Symbol | Fotografia | Rysunek (wymiary w mm) | Pełna nazwa (wymiary w mm) |
|--------|---|---|---|
| Ko13 |  |  | PÓŁKA 280 x 90 x 120, R ~402 |
| Ko06 |  |  | LISTWA ZDOBIENA 227 x 140, R ~370 |
| Ko07 |  |  | LISTWA MASKUJĄCA BRZEGOWA „2” 280 x 70 x 20 |
| Ko08 |  |  | COKÓŁ 247 x 120, R ~402, R ~460 |
| Ko09 |  |  | KAFEL ŚRODKOWY Z WYWIETRZNIKIEM 280 x 227, R ~370 |
| Ko10 |  |  | KAFEL ŚRODKOWY Z WYWIETRZNIKIEM 330 x 247, R ~402 |
| Ko11 |  |  | DEKIELEK Ø190 |

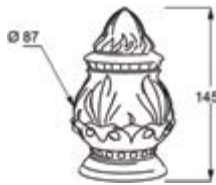

| Symbol | Fotografia | Rysunek (wymiary w mm) | Pełna nazwa (wymiary w mm) |
|--------|--|--|---|
| Ko14L |  |  | KAFEL Z WYCIĘCIEM POD RURĘ DYMOWĄ 280 x 227, R ~370, Ø190 |
| Ko14P |  |  | KAFEL Z WYCIĘCIEM POD RURĘ DYMOWĄ 280 x 227, R ~370, Ø190 |
| Ko15 |  |  | LISTWA ZDOBIONA „MAKI” 150 x 227, R ~370 |
| Ko16 |  |  | COKÓŁ „PROFIL” 145 x 240, R ~387, R ~370 |



PIEC OKRĄGLY „OGAREK Ø90”

| Symbol | Fotografia | Rysunek (wymiary w mm) | Pełna nazwa (wymiary w mm) |
|--------|---|---|--|
| Wer. A |  |  | CZASZA KOMPLET (buławka, podst. buławki, czasza, kafel baza) wys. 640 |
| Wer. B |  |  | WAZA KOMPLET (waza, podstawa wazy, blat, kafel baza) wys. 560 |
| Or01 |  |  | „BUŁAWKA” Ø87, wys. 145 |
| Or02 |  |  | PODSTAWKA „BUŁAWKI” Ø195, wys. 92 |
| Or03 |  |  | CZASZA Ø565, wys. 270 |
| Or04 |  |  | WAZA Ø565, wys. 270 |
| Or05 |  |  | PODSTAWA WAZY Ø336, wys. 156 |

Or07

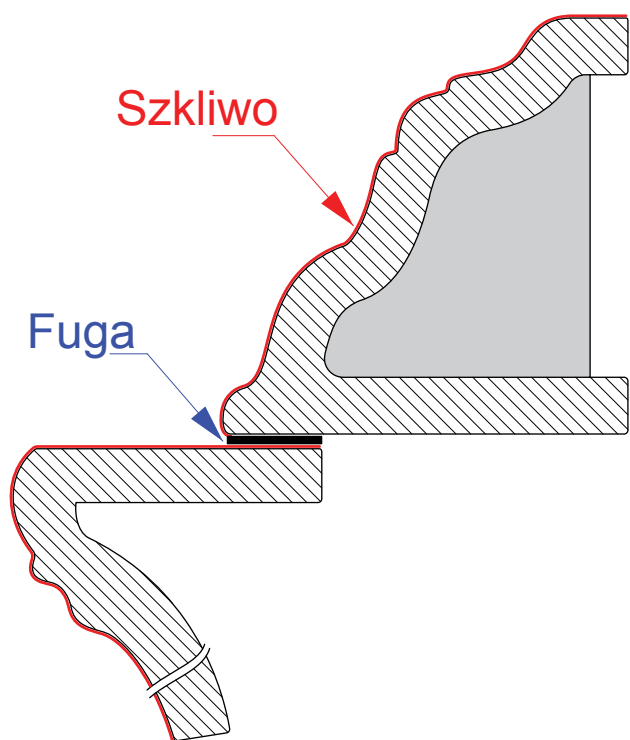

Or10

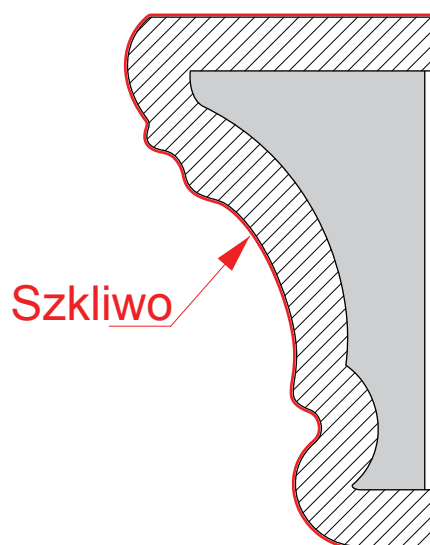



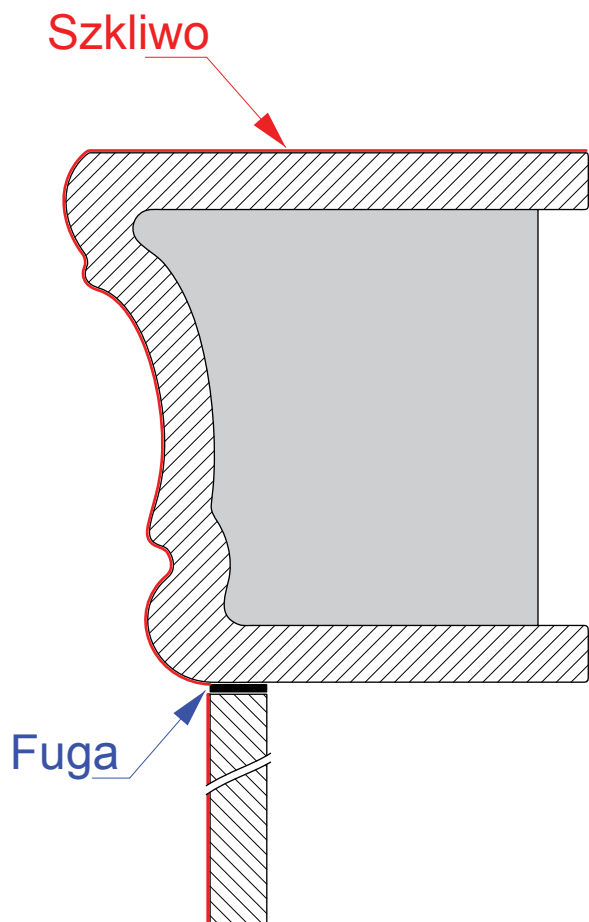



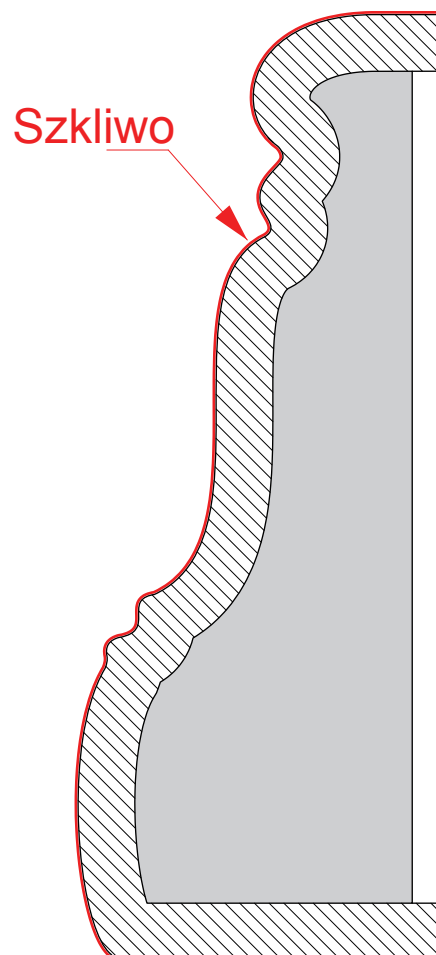





Or13

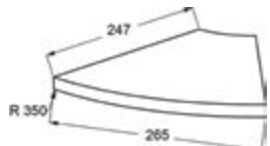

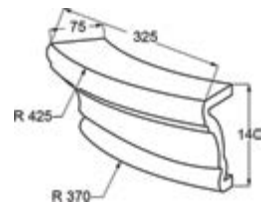
Or16



| Symbol | Fotografia | Rysunek (wymiary w mm) | Pełna nazwa (wymiary w mm) |
|--------|---|---|---|
| Or06 |  |  | PÓŁKA KRYJĄCA (BLAT) R-278, wys. 15 |
| Or07 |  |  | KAFEL BAZA pod CZASZĘ i WAZĘ R-370, wys. 110 |
| Or08 |  |  | DEKIELEK Ø190 |
| Or09 |  |  | KAFEL KRYJĄCY 265 x 247, R-350 |
| Or10 |  |  | GZYMS WIEŃCZĄCY 325 x 75 x 140, R-425 |
| Or11 |  |  | KAFEL ŚRODKOWY 360 x 282 x 50, R-370 |
| Or12 |  |  | KAFEL ŚRODKOWY WENTYLACYJNY 360 x 282 x 50, R-370 |

Wersje złożeniowe

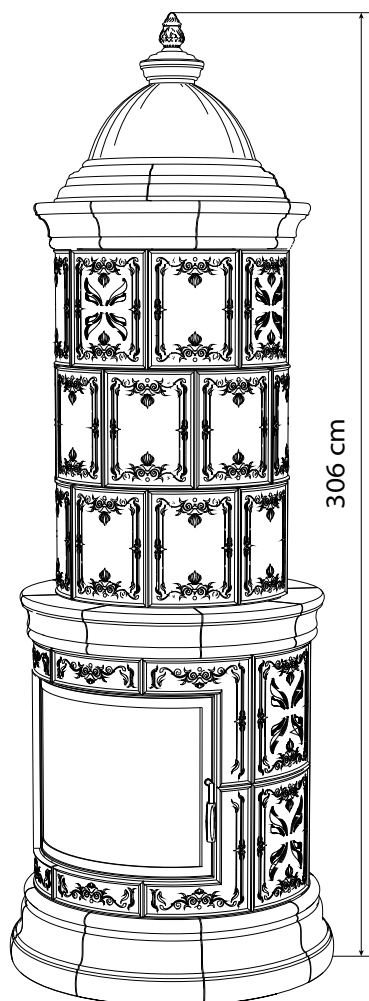

A3

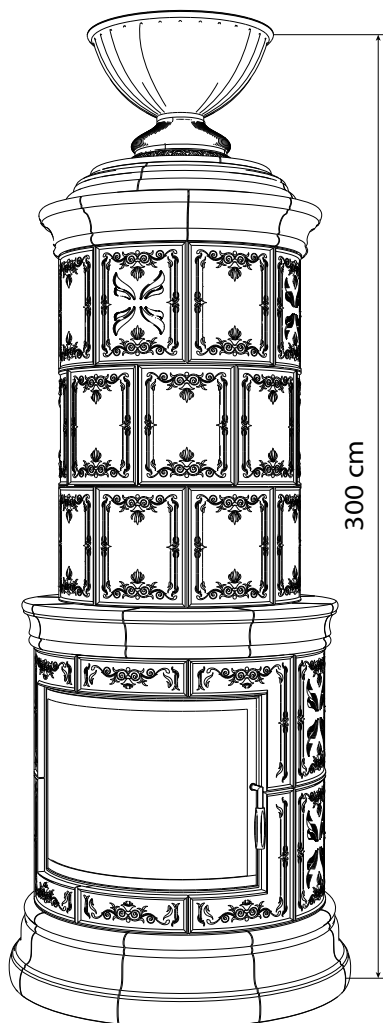

B3

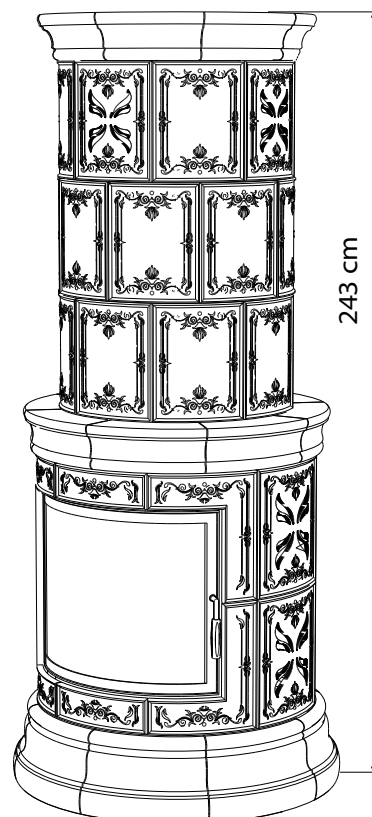

C3

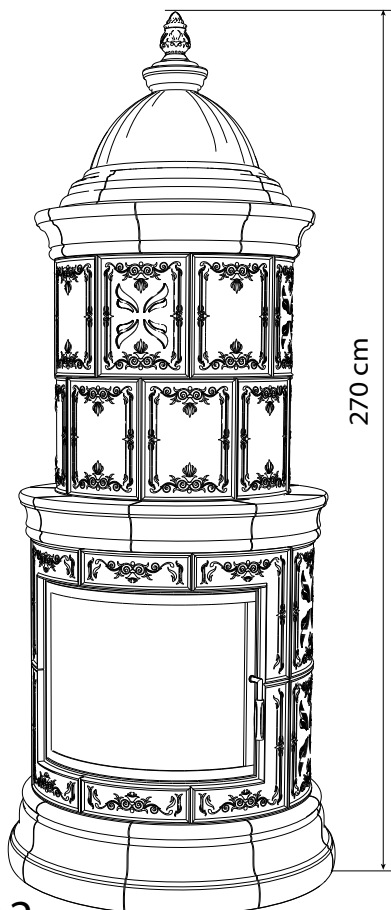



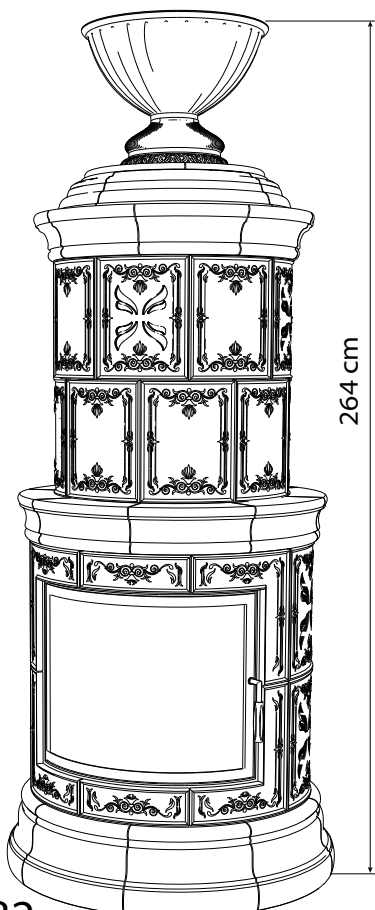



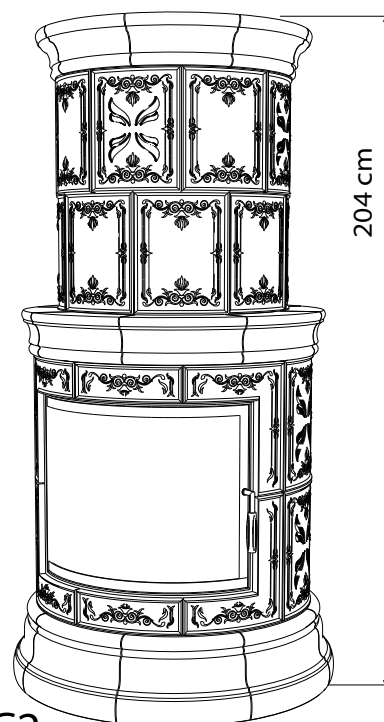



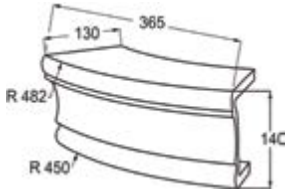

A2

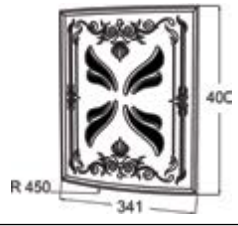

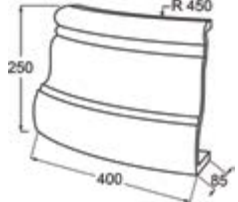

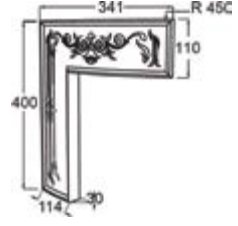

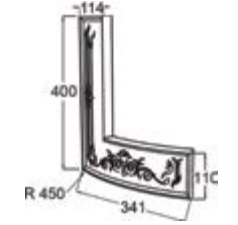

B2

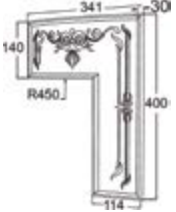

C2

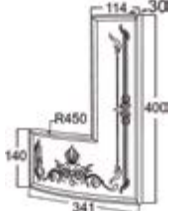
| Symbol | Fotografia | Rysunek (wymiary w mm) | Pełna nazwa (wymiary w mm) |
|--------|---|---|---|
| Or13 |  |  | PÓŁKA 365 x 130 x 140, R-450 |
| Or14 |  |  | KAFEL ŚRODKOWY 400 x 341 x 50, R-450 |
| Or15 |  |  | KAFEL ŚRODKOWY WENTYLACYJNY 400 x 341 x 50, R-450 |
| Or16 |  |  | COKÓŁ 250 x 400 x 85, R-450 |
| Or17 |  |  | KAFEL NAROŻNY (RAMOWY v. A) 400 x 341 x 30, R-450 wysokość wkładu 570 |
| Or18 |  |  | KAFEL NAROŻNY (RAMOWY v. A) 400 x 341 x 30, R-450 wysokość wkładu 570 |
| Or19 |  |  | KAFEL ŚRODKOWY (RAMOWY v. A) 110 x 341 x 30, R-450 wysokość wkładu 570 |

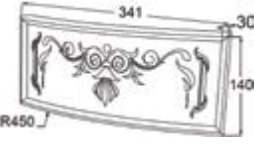





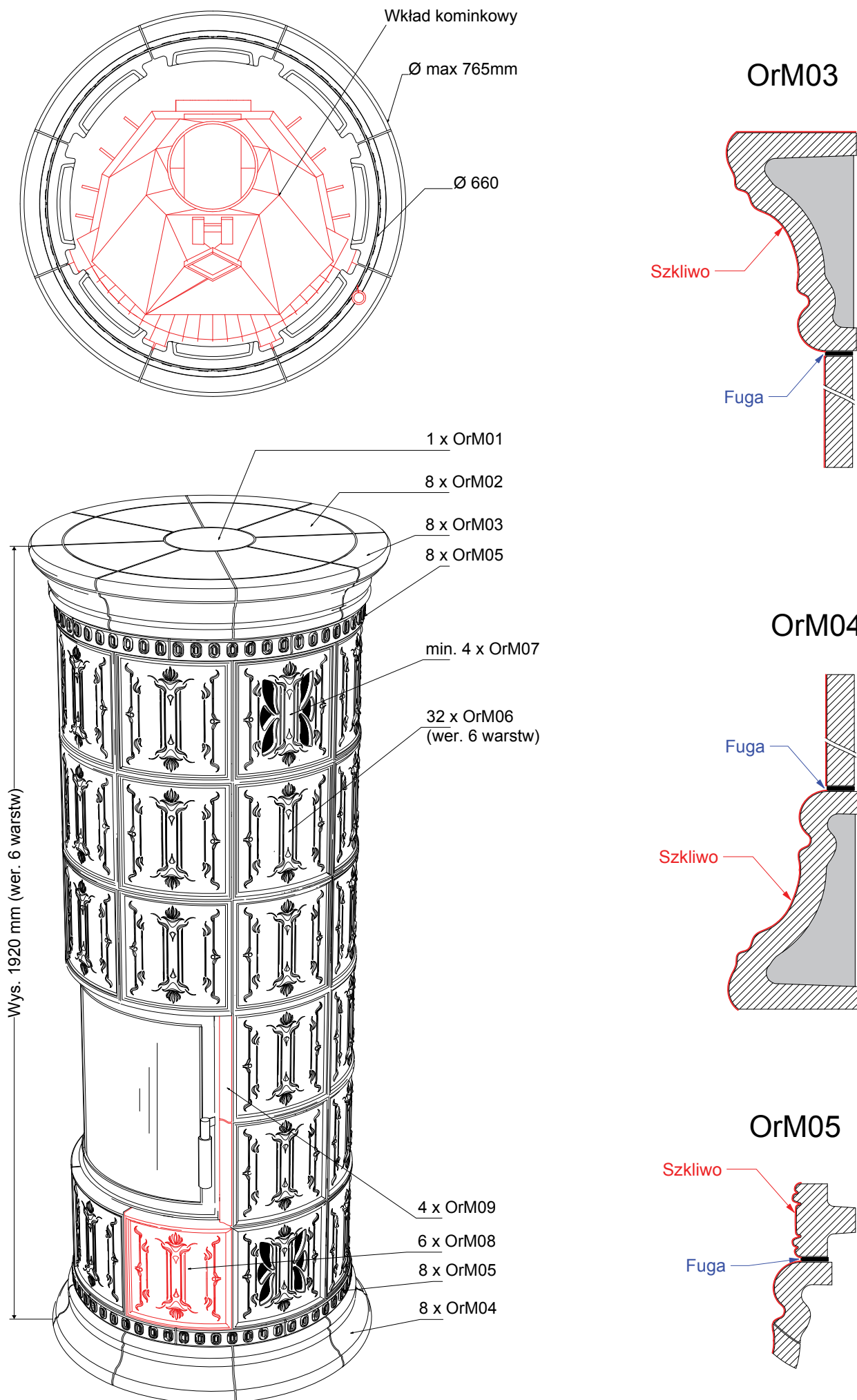



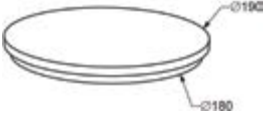
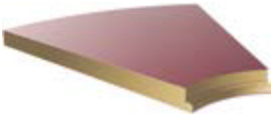
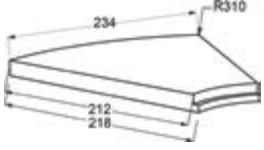

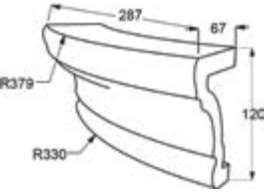
| Symbol | Fotografia | Rysunek (wymiary w mm) | Pełna nazwa (wymiary w mm) |
|--------|--|--|--|
| Or20 |  |  | KAFEL NAROŻNY (RAMOWY _v. B) 400 x 341 x 30, R~450 wysokość wkładu 510 |
| Or21 |  |  | KAFEL NAROŻNY (RAMOWY _v. B) 400 x 341 x 30; R~450 wysokość wkładu 510 |
| Or22 |  |  | KAFEL ŚRODKOWY (RAMOWY _v. B) 140 x 341 x 30; R~450 wysokość wkładu 510 |
| Or23 |  |  | KAFEL ŚRODKOWY Z OTWOREM Ø190 360 x 283 x 50, R~450 |

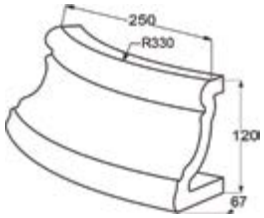

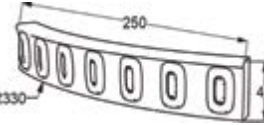

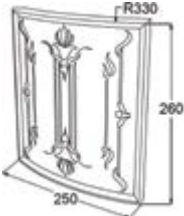
PIEC OKRĄGLY „OGAREK Ø66”

| Symbol | Fotografia | Rysunek (wymiary w mm) | Pełna nazwa (wymiary w mm) |
|--------|---|---|---|
| OrM01 |  |  | DEKIELEK Ø190 |
| OrM02 |  |  | KAFEL KRYJĄCY 234 x 218, R~310 |
| OrM03 |  |  | GZYMS WIEŃCZĄCY 287 x 67 x 120, R~379 |
| OrM04 |  |  | COKÓŁ 250 x 67 x 120, R~330 |
| OrM05 |  |  | LISTWA ZDOBIONA 250 x 40, R~330 |
| OrM06 |  |  | KAFEL ŚRODKOWY 260 x 250 x 36, R~330 |
| OrM07 |  |  | KAFEL ŚRODKOWY WENTYLACYJNY 260 x 250 x 36, R~330 |





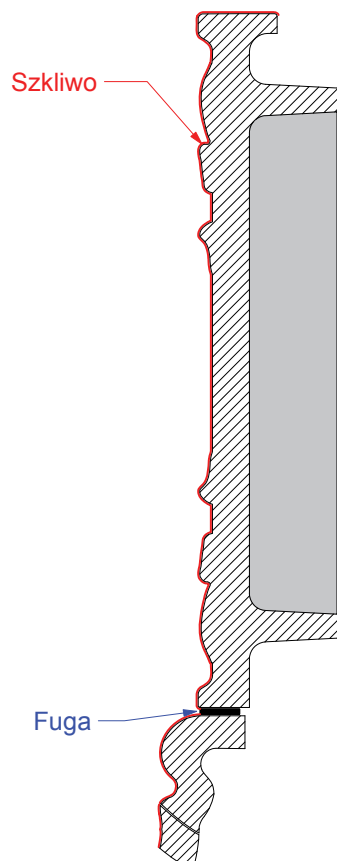

| Symbol | Fotografia | Rysunek (wymiary w mm) | Pełna nazwa (wymiary w mm) |
|--------|---|---|---|
| OrM08 |  |  | KAFEL ŚRODKOWY RAMOWY 260 x 250 x 36, R~330 |
| OrM09 |  |  | LISTWA RAMOWA PIONOWA 260 x 41 x 22 |
| OrM10 |  |  | KAFEL ŚRODKOWY Z OTWOREM Ø190 260 x 250 x 36, R~330 |

OrM08

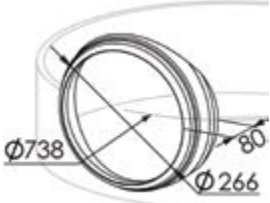

KAFLE „RURA CERAMICZNA Z ROZETAMI”

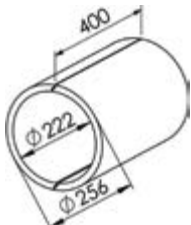
| Symbol | Fotografia | Rysunek (wymiary w mm) | Pełna nazwa (wymiary w mm) |
|--------|--|--|---|
| Ru01 |  |  | ROZETA RURY CERAMICZNEJ (ŚCIENNA) Ø380 x 80, otwór Ø266 |
| Ru02 |  |  | ROZETA RURY CERAMICZNEJ (PIECOWA) Ø380 x 80, otwór Ø266 |
| Ru03 |  |  | RURA CERAMICZNA Ø256 x 400, otwór Ø222 |













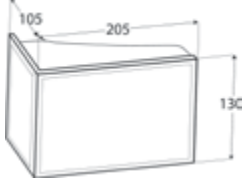



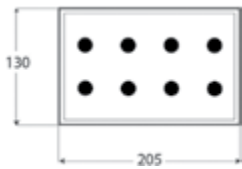

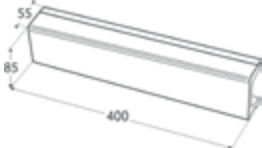
PIECE MINIATURY

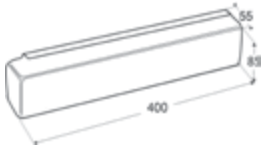
| Symbol | Fotografia | Opakowanie | Pełna nazwa (wymiary w mm) |
|--------|---|---|--|
| M01 |  |  | <p>MINIATURA PIECA ROGALIŃSKIEGO 105 x 80 x 290 Wymiary opakowania 140 x 100 x 325</p> |

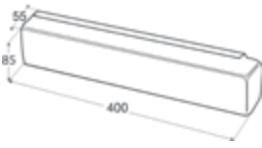

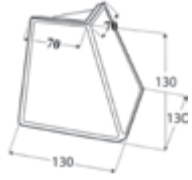

KAFLE „KWADRATELE”

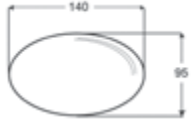
| Symbol | Fotografia | Rysunek (wymiary w mm) | Pełna nazwa (wymiary w mm) |
|--------|---|---|--|
| P01 |  |  | KAFEL ŚRODKOWY 205 x 130 x 45 |
| P02 |  |  | KAFEL NAROŻNY 205 x 130 x 105 |
| P03 |  |  | NOWOŚĆ! KAFEL POŁÓWKA ½ 102 x 130 x 45 |
| P04 |  |  | NOWOŚĆ! KAFEL ŚRODKOWY WENTYLACYJNY 205 x 130 x 45 |
| P05 |  |  | KAFEL WIEŃCOWY ŚRODKOWY 400 x 85 x 55 |
| P06 |  |  | KAFEL WIEŃCOWY LEWY 400 x 85 x 55 |
| P07 |  |  | KAFEL WIEŃCOWY PRAWY 400 x 85 x 55 |
| P08 |  |  | KAFEL OKAPNIKOWY 130 x 130 x 130 |
| P09 |  |  | KAFEL ŚRODKOWY Z OTWOREM 205 x 130 x 45 OTWÓR 125 x 85 |
| P10 |  |  | KOREK 140 x 95 x 35 |

Kafle Kwadrately dostępne wyłącznie w szklwach: 01 ARKTYCZNA BIEL POŁYSK, 02 KREMOWY POŁYSK, 05 ECRU POŁYSK

Tolerancja w wymiarach kafli max +/- 0,5%
Do cen podanych w tabeli należy doliczyć +23% (podatek VAT)

KOLORYSTYKA KAFLI

KOLORY PODSTAWOWE



01 ARKTYCZNA BIEL
POŁYSK



02 KREMOWY
POŁYSK



03 MORELA POŁYSK



05 ECRU POŁYSK



06 BŁĘKIT
POŁUDNIA POŁYSK

KOLORY Z DOPŁATĄ 10%



21 BEŻ MAT



22 VANILIA MAT



23 PERŁA MAT



24 CAPPUCINO MAT



26 LAWENDA MAT

KOLORY Z DOPŁATĄ 20%



04 BRAZ
TRANSPARENTNY*



201 MIDNIGHT BLUE
TRANSPARENTNY*



25 KOBALT
TRANSPARENTNY*



30 SŁONECZNIKOWY
TRANSPARENTNY*



31 WRZOSOWY
TRANSPARENTNY*

KOLORY Z DOPŁATĄ 30%



27 LAZUROWY
TRANSPARENTNY*



28 MIODOWY
TRANSPARENTNY*



52 OLIWKA
TRANSPARENTNA*



55 ZIELEŃ
BUTELKOWA
TRANSPARENTNA*



51 BEŻ CRACLE MAT

KOLORY Z DOPŁATĄ 40%



71 CZERWIEN
ZACHODU



73 KARMAZYNOWA
CZERWIEN



75 METALICZNY
BRAZ



76 ORANGE
POŁYSK



**07 CZERNÍ
FORTEPIANOWA
POŁYSK**



08 SZARY POŁYSK



72 GRAFIT MAT



**29 RÓŻ WENECKI
MAT**



32 SAHARA MAT



33 SIENA MAT



35 SZARY MAT



**74 MALINOWY
TRANSPARENTNY***



**34 LNIANY
TRANSPARENTNY***



11 KHAKI MAT



**53 POPIELATY
CRACLE**

Przedstawiona kolorystyka kafli może nieznacznie odbiegać od rzeczywistych kolorów.

*przy szkliwach transparentnych mogą wystąpić przebarwienia i harysowanie co jest cechą naturalną.

**KOLORY NA
INDYWIDUALNE
ZAMÓWIENIE
DOPŁATA
60%**



**ZDOBIENIA
– DOPŁATA
150%**



**101 ZDOBIONE
ZŁOTEM**



**102 ZDOBIONE
PLATYNĄ**

PRZYKŁADY ZLECEŃ INDYWIDUALNYCH



1



2



3



4

PRZYKŁADY ZLECEŃ INDYWIDUALNYCH



Grafika



Wizualizacja



Biskwit



Szklwienie i zdobienie



1



2



3



4



5



6



7



8



9



10

PRZYKŁADY ZLECEŃ INDYWIDUALNYCH



Rysunek

Wizualizacja

Efekt końcowy

11



12



13

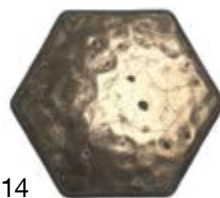

14



15



16



20

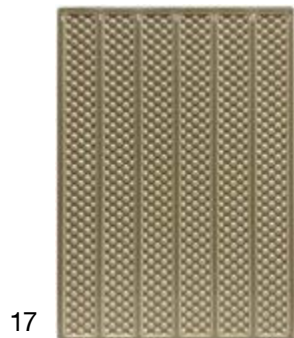

17



18



19



21



22



23



24



25



26

KAFLE MALOWANE



1



2



3



4



5



6



7



10



8



9



11

KAFLE MALOWANE



12



13



14



15



16



17



18



19



20



21



22



23



26



24



25



27



28



29



30



31



32



33



36



34



35



37



38



39

KAFLE MALOWANE



40



41



42



43



44



45



46



47

PRZYKŁADY KAFLE ZDOBIONYCH ZŁOTEM I PLATYNĄ



48



49



50



51



52



53



54

szkliwo:

data:

Zamówienie nr. _____

K A F L A R N I A
KAFEL-KAR
 Hryniewicze 3B, 15-378 BIAŁYSTOK
 tel. 85 747 49 80
 kaffe@kafel-kar.pl www.kafel-kar.pl

1

Nazwa _____

Kontakt _____

| Symbol | KAFLE „CLASSIC” 25 cm | Cena | Kolor | Kolor | Ilość szt. | Ilość szt. |
|----------|--|------|-------|-------|------------|------------|
| Ca01 | KAFEL ŚRODKOWY 250 x 220 x 50 | | | | | |
| Ca02 | KAFEL ŚRODKOWY GŁADKI 250 x 220 x 50 | | | | | |
| Ca03 | KAFEL NAROŻNY OSTRY 250 x 110 x 110 | | | | | |
| Ca04 | KAFEL NAROŻNY OSTRY „L” 250 x 220 x 110 | | | | | |
| Ca05 | KAFEL POŁÓWKA ½ 250 x 110 x 50 | | | | | |
| Ca06 | KAFEL ŚRODKOWY Z WYWIETRZNIKIEM „1” 250 x 220 x 50 | | | | | |
| Ca07 | KAFEL ŚRODKOWY Z WYWIETRZNIKIEM „2” 250 x 220 x 50 | | | | | |
| Ca08 | KAFEL ŚRODKOWY REWIZYJNY 250 x 220 x 50, otwór 145 x 175 | | | | | |
| Ca09 | GZYMS ŚRODKOWY PRZEWEĘŻENIE 220 x 55 x 100, 220 x 110 | | | | | |
| Ca09/1 | GZYMS ŚRODKOWY 220 x 110, 220 x 55 x 100 | | | | | |
| Ca10 | GZYMS NAROŻNY PRZEWEĘŻENIE 220 x 220 x 100, 275 x 275 | | | | | |
| Ca10/1 | GZYMS NAROŻNY 275 x 275, 220 x 220 x 100 | | | | | |
| Ca11 | PÓŁKA ŚRODKOWA 280 x 170 x 180, 280 x 210 | | | | | |
| Ca12 | PÓŁKA ROGOWA 280 x 280 x 180 dół 220 x 220 x 180 półka 170 x 170 | | | | | |
| Ca13 | KORONA z narożnikami 890 x 680 x 110 | | | | | |
| Ca14 | GZYMS WIEŃCZĄCY ŚRODKOWY 440 x 280 x 110, podstawa 440 x 40 | | | | | |
| Ca15 | GZYMS WIEŃCZĄCY NAROŻNY podst. 110 x 110 x 360, góra 205 x 205 | | | | | |
| Symbol | KAFLE „ECHO” | Cena | Kolor | Kolor | Ilość szt. | Ilość szt. |
| !! Ec01w | KAFEL ŚRODKOWY 300 x 300 x 55 (bez rompy, wewnętrzny) | | | | | |
| !! Ec01z | KAFEL ŚRODKOWY 300 x 300 x 55 (bez rompy, zewnętrzny) | | | | | |
| Ec02 | KAFEL ŚRODKOWY „I” 300 x 300 x 20 (bez rompy) | | | | | |
| Ec03 | KAFEL ŚRODKOWY „II” 440 x 300 x 20 (bez rompy) | | | | | |
| Ec04 | KAFEL ŚRODKOWY „III” 440 x 200 x 20 (bez rompy) | | | | | |
| Ec05 | KAFEL NAROŻNY ZAOKRĄGLONY „I” 300 x 110 x 110 (bez rompy) | | | | | |
| Gb07 | KAFEL NAROŻNY ZAOKRĄGLONY 440 x 110 x 110 | | | | | |
| Gb08 | KAFEL NAROŻNY ZAMYKAJĄCY ZAOKR. 110 x 110 x 110 (bez rompy) | | | | | |

FORMULARZ ZAMÓWIENIA

CENY NETTO

v.7 obowiązuje od 01.01.2024

* Wypełnić tylko w przypadku, gdy wymaga tego zamówienie

Do zapłaty * _____

Zamówienie nr. _____

K A F L A R N I A
KAFEL-KAR
 Hryniewicze 3B, 15-378 BIAŁYSTOK
 tel. 85 747 49 80
 kafle@kafel-kar.pl www.kafel-kar.pl

2

Nazwa _____

Kontakt _____

| Symbol | KAFLE „BRAMA” | Cena | Kolor | Kolor | Ilość szt. | Ilość szt. |
|--------|---|------|-------|-------|------------|------------|
| Kb01 | KAFEL ŚRODKOWY 220 x 220 x 50 | | | | | |
| Kb02 | KAFEL NAROŻNY ZAOKRĄGLONY 220 x 110 x 110 | | | | | |
| Kb03 | KAFEL NAROŻNY OSTRY 220 x 110 x 110 | | | | | |
| Kb04 | KAFEL POŁÓWKA ½ 220 x 110 x 50 | | | | | |
| Kb05 | KAFEL ŚRODKOWY Z WYWIETRZNIKIEM 220 x 220 x 50 | | | | | |
| Kb06 | KAFEL OZDOBNY „SOWA” 220 x 220 x 50 | | | | | |
| Symbol | KAFLE „TALERZ CIĘTY” | Cena | Kolor | Kolor | Ilość szt. | Ilość szt. |
| Kt01 | KAFEL ŚRODKOWY 220 x 220 x 50 | | | | | |
| Kt02 | KAFEL NAROŻNY ZAOKRĄGLONY 220 x 110 x 110 | | | | | |
| Kt03 | KAFEL POŁÓWKA ½ 220 x 110 x 50 | | | | | |
| Kt04 | KAFEL ŚRODKOWY Z WYWIETRZNIKIEM „1” 220 x 220 x 50 | | | | | |
| Kt05 | KAFEL ŚRODKOWY Z WYWIETRZNIKIEM „2” 220 x 220 x 50 | | | | | |
| Kt06 | KAFEL NAROŻNY OSTRY 220 x 110 x 110 | | | | | |
| Kt07 | KAFEL OZDOBNY „JELEŃ” 220 x 220 x 50 | | | | | |
| Kt08 | KAFEL OZDOBNY „SOWA” 220 x 220 x 50 | | | | | |
| Symbol | KAFLE „GŁADKIE” | Cena | Kolor | Kolor | Ilość szt. | Ilość szt. |
| Kp01 | KAFEL ŚRODKOWY 220 x 220 x 50 | | | | | |
| Kp02 | KAFEL NAROŻNY OSTRY 220 x 110 x 110 | | | | | |
| Kp03 | KAFEL NAROŻNY OSTRY „L” 220 x 220 x 110 | | | | | |
| Kp04 | KAFEL POŁÓWKA ½ 220 x 110 x 50 | | | | | |
| Kp05 | KAFEL NAROŻNY ZAOKRĄGLONY 220 x 110 x 110 | | | | | |
| Kp16 | KAFEL NAROŻNY ROZWARTY 135° 220 x 220 x 110 | | | | | |
| Kp06 | KOREK OKRĄGLY Ø135 | | | | | |
| Kp07 | KAFEL Z OTWOREM OKRĄGLYM Ø120, 220 x 220 x 50 | | | | | |
| Kp08 | KAFEL ŚRODKOWY Z WYWIETRZNIKIEM „1” 220 x 220 x 50 | | | | | |
| Kp09 | KAFEL ŚRODKOWY Z WYWIETRZNIKIEM „2” 220 x 220 x 50 | | | | | |
| Kp10 | KAFEL ŚRODKOWY Z WYWIETRZNIKIEM „3” 220 x 220 x 50 | | | | | |
| Kp17 | KAFEL ŚRODKOWY Z WYWIETRZNIKIEM „4” 220 x 220 x 50 | | | | | |
| Kp18 | KAFEL ŚRODKOWY Z WYWIETRZNIKIEM „5” 220 x 220 x 50 | | | | | |
| Kp11 | PŁYTKA ŚRODKOWA 220 x 220 x 14 | | | | | |
| Kp12 | PŁYTKA ŚRODKOWA 250 x 220 x 14 | | | | | |
| Kp13 | LISTWA MASKUJĄCA BRZEGOWA „1” 280 x 130 x 30 | | | | | |
| Kp14 | KAFEL Z OTWOREM KWADRATOWYM 155 x 155, 220 x 220 x 50 | | | | | |
| Kp15 | KOREK KWADRATOWY 180 x 180 x 38 | | | | | |
| Kp15a | KOREK KWADRATOWY Z WYWIETRZNIKIEM 180 x 180 x 38 | | | | | |
| Kp19 | KAFEL REWIZYJNY 220 x 220 x 50, otwór 155 x 155 | | | | | |
| Kp20 | KAFEL NAROŻNY ZAMYKAJĄCY ZAOKR. 110 x 110 x 110 (bez rompy) | | | | | |
| Symbol | KAFLE „RAMKOWE” | Cena | Kolor | Kolor | Ilość szt. | Ilość szt. |
| Ra01 | KAFEL ŚRODKOWY 220 x 220 x 50 | | | | | |
| Ra02 | KAFEL NAROŻNY ZAOKRĄGLONY 110 x 110 x 220 | | | | | |
| Ra03 | KAFEL NAROŻNY OSTRY 220 x 110 x 110 | | | | | |
| Ra04 | KAFEL POŁÓWKA 220 x 110 x 50 | | | | | |
| Ra05 | KAFEL ŚRODKOWY Z WYWIETRZNIKIEM 220 x 220 x 50 | | | | | |
| Ra06 | KAFEL Z OTWOREM OKRĄGLYM Ø120, 220 x 220 x 50 | | | | | |
| Ra07 | KAFEL Z OTWOREM KWADRATOWYM 155 x 155, 220 x 220 x 50 | | | | | |

FORMULARZ ZAMÓWIENIA

CENY NETTO

v.7 obowiązuje od 01.01.2024

* Wypełnić tylko w przypadku, gdy wymaga tego zamówienie

Do zapłaty * _____

Zamówienie nr. _____

K A F L A R N I A
KAFEL-KAR
 Hryniewicze 3B, 15-378 BIAŁYSTOK
 tel. 85 747 49 80
 kafle@kafel-kar.pl www.kafel-kar.pl

3

Nazwa _____

Kontakt _____

| Symbol | KAFLE „DWORSKIE” | Cena | Kolor | Kolor | Ilość szt. | Ilość szt. |
|---------|---|------|-------|-------|------------|------------|
| Dw01 | KAFEL ŚRODKOWY 220 x 220 x 50 | | | | | |
| Dw02 | KAFEL NAROŻNY OSTRY 220 x 110 x 110 | | | | | |
| Dw03 | KAFEL NAROŻNY „L” 220 x 220 x 110 | | | | | |
| Dw04 | KAFEL POŁÓWKA ½ 220 x 110 x 50 | | | | | |
| Dw05 | KAFEL ŚRODKOWY Z WYWIETRZNIKIEM 220 x 220 x 50 | | | | | |
| Dw06 | KAFEL NAROŻNY ½ „L” 220 x 110 x 110 | | | | | |
| Dw07 | GZYMS ŚRODKOWY 220 x 120 x 110 | | | | | |
| Dw07/1 | GZYMS ŚRODKOWY 220 x 120 x 110 | | | | | |
| Dw09L | GZYMS NAROŻNY OSTRY 220 x 110 x 120, 275 x 165, R-2 | | | | | |
| Dw09L/1 | GZYMS NAROŻNY OSTRY 275 x 165, 220 x 110 x 120, R-2 | | | | | |
| Dw09P | GZYMS NAROŻNY OSTRY 220 x 110 x 120, 275 x 165, R-2 | | | | | |
| Dw09P/1 | GZYMS NAROŻNY OSTRY 275 x 165, 220 x 110 x 120, R-2 | | | | | |
| Dw10 | KAFEL Z OTWOREM OKRĄGLYM ø120, 220 x 220 x 50 | | | | | |
| Dw11 | KAFEL Z OTWOREM KWADRATOWYM 155 x 155, 220 x 220 x 50 | | | | | |
| Dw12 | KAFEL NAROŻNY OSTRY 220 x 110 x 110, R-2, GŁADKI | | | | | |
| Dw13 | KAFEL NAROŻNY OSTRY „L” 220 x 220 x 110, R-2, GŁADKI | | | | | |
| Symbol | KAFLE „FORMAT” 28 cm | Cena | Kolor | Kolor | Ilość szt. | Ilość szt. |
| Fm01 | KAFEL ŚRODKOWY 280 x 220 x 50 | | | | | |
| Fm02 | KAFEL NAROŻNY ZAOKRĄGLONY 280 x 110 x 110 | | | | | |
| Fm03 | KAFEL NAROŻNY OSTRY 280 x 110 x 110 | | | | | |
| Fm14 | KAFEL NAROŻNY OSTRY „L” 280 x 220 x 110 | | | | | |
| Fm04 | KAFEL POŁÓWKA ½ 280 x 110 x 50 | | | | | |
| Fm05 | KAFEL ŚRODKOWY Z WYWIETRZNIKIEM „1” 280 x 220 x 50 | | | | | |
| Fm11 | KAFEL ŚRODKOWY Z WYWIETRZNIKIEM „2” 280 x 220 x 50 | | | | | |
| Fm06 | KAFEL NAROŻNY OSTRY ZEWNĘTRZNY 280 x 110 x 110 | | | | | |
| Fm07 | KAFEL NAROŻNY OSTRY WEWNĘTRZNY 280 x 110 x 110 | | | | | |
| Fm08 | KAFEL NAROŻNY ZAMYKAJĄCY 110 x 110 x 110 | | | | | |
| Fm09 | KAFEL NAROŻNY ZAOKRĄGLONY 280 x 165 x 165 | | | | | |
| Fm10 | KAFEL NAROŻNY OSTRY 280 x 165 x 165 | | | | | |
| Fm12 | KAFEL Z OTWOREM OKRĄGLYM ø120, 280 x 220 x 50 | | | | | |
| Fm13 | KAFEL Z OTWOREM KWADRATOWYM 155 x 155, 280 x 220 x 50 | | | | | |
| Fm15 | KAFEL REWIZYJNY 280 x 220 x 50, otwór 155 x 155 | | | | | |
| Fm16 | KAFEL NAROŻNY ŁAMANY 280 x 165 x 165 | | | | | |
| Fm17 | KAFEL ŚRODKOWY Z WYWIETRZNIKIEM „3” 280 x 220 x 50 | | | | | |
| Fm18 | KAFEL ŚRODKOWY Z WYWIETRZNIKIEM „4” 280 x 220 x 50 | | | | | |
| Fm19 | PŁYTKA ŚRODKOWA 280 x 220 x 14 | | | | | |
| Fm20 | KAFEL OZDOBNY „ARCHANIOŁ” 280 x 220 x 50 | | | | | |
| Symbol | KAFLE „OGARKI” | Cena | Kolor | Kolor | Ilość szt. | Ilość szt. |
| Og01 | KAFEL ŚRODKOWY 280 x 220 x 50 | | | | | |
| Og02 | KAFEL NAROŻNY ZAOKRĄGLONY 280 x 110 x 110 | | | | | |
| Og03 | KAFEL NAROŻNY OSTRY 280 x 110 x 110 | | | | | |
| Og04 | KAFEL POŁÓWKA ½ 280 x 110 x 50 | | | | | |
| Og05 | KAFEL NAROŻNY ZAOKRĄGLONY 280 x 165 x 165 | | | | | |
| Og06 | KAFEL NAROŻNY OSTRY 280 x 165 x 165 | | | | | |
| Og07 | KAFEL ŚRODKOWY Z WYWIETRZNIKIEM 280 x 220 x 50 | | | | | |
| Og08 | KAFEL Z OTWOREM OKRĄGLYM ø120, 280 x 220 x 50 | | | | | |

FORMULARZ ZAMÓWIENIA

CENY NETTO

v.7 obowiązuje od 01.01.2024

* Wypełnić tylko w przypadku, gdy wymaga tego zamówienie

Do zapłaty * _____

Zamówienie nr. _____

Nazwa _____

Kontakt _____

| Symbol | KAFLE „VINTAGE” | Cena | Kolor | Kolor | Ilość szt. | Ilość szt. |
|--------|---|------|-------|-------|------------|------------|
| V01 | KAFEL ŚRODKOWY 280 x 220 x 50 | | | | | |
| V02 | KAFEL NAROŻNY ZAOKRĄGLONY 280 x 110 x 110 | | | | | |
| V03 | KAFEL NAROŻNY OSTRY 280 x 110 x 110 | | | | | |
| V04 | KAFEL NAROŻNY OSTRY „L” 280 x 220 x 110 | | | | | |
| V05 | KAFEL POŁÓWKA ½ 280 x 110 x 50 | | | | | |
| V06 | KAFEL ŚRODKOWY Z WYWIETRZNIKIEM 280 x 220 x 50 | | | | | |
| V07 | KAFEL NAROŻNY ŁAMANY 280 x 110 x 110 | | | | | |
| V08 | KAFEL ĆWIARTKA ¼ 280 x 55 | | | | | |
| V09 | KAFEL NAROŻNY ZAOKRĄGLONY 280 x 165 x 165 | | | | | |
| V10 | KAFEL NAROŻNY OSTRY 280 x 165 x 165 | | | | | |
| V11 | KAFEL NAROŻNY ŁAMANY 280 x 165 x 165 | | | | | |
| Symbol | KAFLE „FORMAT” 44 cm | Cena | Kolor | Kolor | Ilość szt. | Ilość szt. |
| F01 | KAFEL ŚRODKOWY 440 x 220 x 45 | | | | | |
| F02 | KAFEL NAROŻNY ZAOKRĄGLONY 440 x 110 x 110 | | | | | |
| F03 | KAFEL NAROŻNY OSTRY 440 x 110 x 110 | | | | | |
| F04 | KAFEL POŁÓWKA ½ 440 x 110 x 45 | | | | | |
| F05 | KAFEL ŚRODKOWY Z WYWIETRZNIKIEM „1” 440 x 220 x 45 | | | | | |
| F09 | KAFEL ŚRODKOWY Z WYWIETRZNIKIEM „2” 440 x 220 x 45 | | | | | |
| F06 | KAFEL NAROŻNY „L” 440 x 220 x 110 | | | | | |
| F07 | KAFEL NAROŻNY „L” TYP II, 440 x 220 x 110 | | | | | |
| F08P | KAFEL NAROŻNY ZAMYKAJĄCY PRAWY 440 x 220 x 110 | | | | | |
| F08L | KAFEL NAROŻNY ZAMYKAJĄCY LEWY 440 x 220 x 110 | | | | | |
| F10 | KAFEL REWIZYJNY 440 x 220 x 45, otwór 155 x 155 | | | | | |
| F11 | PLYTKA ŚRODKOWA 440 x 220 x 14 | | | | | |
| Symbol | KAFLE „GABARYT” | Cena | Kolor | Kolor | Ilość szt. | Ilość szt. |
| Gb02 | KAFEL ŚRODKOWY 660 x 440 x 20 (bez rompy) | | | | | |
| Gb03 | KAFEL ŚRODKOWY 440 x 440 x 20 (bez rompy) | | | | | |
| Gb04 | KAFEL NAROŻNY 440 x 110 x 110, R-2 (bez rompy) | | | | | |
| Gb05 | KAFEL NAROŻNY WIĘCZĄCY 660 x 110 x 110, R-2 (bez rompy) | | | | | |
| Gb06 | KAFEL NAROŻNY ZAMYKAJĄCY 110 x 110 x 110, R-2 (bez rompy) | | | | | |
| Gb07 | KAFEL NAROŻNY ZAOKRĄGLONY 440 x 110 x 110 (bez rompy) | | | | | |
| Gb08 | KAFEL NAROŻNY ZAMYKAJĄCY ZAOKR. 110 x 110 x 110 (bez rompy) | | | | | |
| Gb_A | „RÓŻA” komplet kafli 4 szt. - 660 x 440 x 20 (bez rompy) | | | | | |
| Gb_B | „RAJSKI PTAK” komplet kafli 8 szt. - 440 x 440 x 20 (bez rompy) | | | | | |
| Symbol | KAFLE „MILITARY” | Cena | Kolor | Kolor | Ilość szt. | Ilość szt. |
| Gm01 | KAFEL ŚRODKOWY 660 x 440 x 20 (bez rompy) | | | | | |
| Gm02 | KAFEL ŚRODKOWY 440 x 440 x 20 (bez rompy) | | | | | |
| Gm03 | KAFEL NAROŻNY 440 x 110 x 110, R-2 (bez rompy) | | | | | |
| Gm04 | KAFEL NAROŻNY WIĘCZĄCY 660 110 x 110, R-2 (bez rompy) | | | | | |
| Gm05 | KAFEL NAROŻNY ZAMYKAJĄCY 110 x 110 x 110, R-2 (bez rompy) | | | | | |
| Symbol | DEFLEKTORY | Cena | Kolor | Kolor | Ilość szt. | Ilość szt. |
| Df01 | DEFLEKTOR KAFLI „220” Z WYWIETRZNIKIEM, 200 x 200 x 35 | | | | | |
| Df02 | DEFLEKTOR KAFLI „280” Z WYWIETRZNIKIEM, 250 x 200 x 35 | | | | | |
| Df03 | DEFLEKTOR KAFLI „440” Z WYWIETRZNIKIEM, 415 x 200 x 35 | | | | | |
| Df04 | DEFLEKTOR KAFLI Ko09 Z WYWIETRZNIKIEM, 250 x 200 x 35 | | | | | |
| Df05 | DEFLEKTOR KAFLI Ko10 Z WYWIETRZNIKIEM, 280 x 200 x 35 | | | | | |
| Df06 | DEFLEKTOR KAFLI Or12 Z WYWIETRZNIKIEM, 330 x 230 x 30 | | | | | |
| Df07 | DEFLEKTOR KAFLI Or15 Z WYWIETRZNIKIEM, 360 x 280 x 35 | | | | | |

FORMULARZ ZAMÓWIENIA

CENY NETTO

v.7 obowiązuje od 01.01.2024

* Wypełnić tylko w przypadku, gdy wymaga tego zamówienie

Do zapłaty * _____

Zamówienie nr. _____

Nazwa _____

Kontakt _____

| Symbol | KAFLE PÓLKI „6” | Cena | Kolor | Kolor | Ilość szt. | Ilość szt. |
|----------|---|------|-------|-------|------------|------------|
| K01 | PÓLKA ŚRODKOWA 220 x 250 x 60 | | | | | |
| K01/1 | PÓLKA ŚRODKOWA 250 x 250 x 60 | | | | | |
| K02/Kp11 | PÓLKA ŚRODKOWA KRYJĄCA 220 x 220 x 17 | | | | | |
| K03 | PÓLKA ROGOWA ZAOKRĄGLONA 250 x 250 x 60 | | | | | |
| K04 | PÓLKA ROGOWA OSTRA 250 x 250 x 60 | | | | | |
| K05 | PÓLKA ROGOWA OSTRA 135° 110 x 110 x 60 | | | | | |
| Symbol | KAFLE WIĘNCOWE „6” | Cena | Kolor | Kolor | Ilość szt. | Ilość szt. |
| K06 | KAFEL WIĘNCOWY ŚRODKOWY 220 x 95 x 60 | | | | | |
| K07 | KAFEL WIĘNCOWY NAROŻNY ZAOKRĄGLONY 250 x 250 x 60 | | | | | |
| K08 | KAFEL WIĘNCOWY NAROŻNY OSTRY 250 x 250 x 60 | | | | | |
| K09 | PÓLKA R~550, 220 x 250 x 125 | | | | | |
| K10 | ELEMENT DO PÓLKI K09 R-550, 125 x 200 x 50 | | | | | |
| K11 | KAFEL WIĘNCOWY OSTRY 135° 110 x 110 x 60 | | | | | |
| Symbol | KAFLE PÓLKI „3” SLIM | Cena | Kolor | Kolor | Ilość szt. | Ilość szt. |
| S01 | PÓLKA ŚRODKOWA 220 x 220 x 30 | | | | | |
| S02 | PÓLKA ŚRODKOWA 250 x 220 x 30 | | | | | |
| S03 | PÓLKA ROGOWA ZAOKRĄGLONA 220 x 220 x 30 | | | | | |
| S04 | PÓLKA ROGOWA OSTRA 220 x 220 x 30 | | | | | |
| S05 | PÓLKA ROGOWA OSTRA 135° 110 x 110 x 30 | | | | | |
| Symbol | KAFLE PÓLKI „WYSOKIE” | Cena | Kolor | Kolor | Ilość szt. | Ilość szt. |
| Kz01 | PÓLKA ŚRODKOWA 220 x 182 x 165 - GŁADKA | | | | | |
| Kz02 | PÓLKA NAROŻNA ZAOKR. 182 x 182 x 165, 110 x 110 - GŁADKA | | | | | |
| Kz03 | PÓLKA NAROŻNA OSTRA 182 x 182 x 165, 110 x 110 - GŁADKA | | | | | |
| Kz04 | PÓLKA NAROŻNA ŁAMANA 182 x 182 x 165, 110 x 110 - GŁADKA | | | | | |
| Symbol | KAFLE PÓLKI „SECESJA” | Cena | Kolor | Kolor | Ilość szt. | Ilość szt. |
| Kz06 | PÓLKA ŚRODKOWA 220 x 170 x 150, 220 x 110 | | | | | |
| Kz07 | PÓLKA NAROŻNA OSTRA 170 x 170 x 150, 110 x 110 | | | | | |
| Symbol | KAFLE PÓLKI „ZDOBIONE” | | Kolor | Kolor | Ilość szt. | Ilość szt. |
| Pz01 | PÓLKA ŚRODKOWA 220 x 165 x 165 | | | | | |
| Pz02 | PÓLKA NAROŻNA ZAOKRĄGLONA 165 x 165, 110 x 110 x 165 | | | | | |
| Pz03 | PÓLKA NAROŻNA OSTRA 165 x 165, 110 x 110 x 165 | | | | | |
| Pz04 | PÓLKA NAROŻNA ŁAMANA 165 x 165, 110 x 110 x 165 | | | | | |
| Symbol | KAFLE PÓLKI „VINTAGE” | | Kolor | Kolor | Ilość szt. | Ilość szt. |
| V12 | PÓLKA ŚRODKOWA 220 x 220 x 165 | | | | | |
| V13 | PÓLKA ROGOWA ZAOKRĄGLONA 220 x 220, 110 x 110 x 165 | | | | | |
| V14 | PÓLKA ROGOWA OSTRA 220 x 220, 110 x 110 x 165 | | | | | |
| V15 | PÓLKA ROGOWA ŁAMANA 220 x 220, 110 x 110 x 165 | | | | | |
| V16 | PÓLKA ROGOWA 135° 220 x 220, 110 x 110 x 165 | | | | | |
| Symbol | LISTWY DYSTANSOWE | | Kolor | Kolor | Ilość szt. | Ilość szt. |
| Ld01 | LISTWA DYSTANSOWA ŚRODKOWA „DECO” 220 x 60 | | | | | |
| Ld02 | LISTWA DYSTANSOWA ZAOKRĄGLONA „DECO” 110 x 110 x 60 | | | | | |
| Ld03 | LISTWA DYSTANSOWA NAROŻNA OSTRA „DECO” 110 x 110 x 60 | | | | | |
| Ld04 | LISTWA DYSTANSOWA ŚRODKOWA „FAUN” 220 x 60 | | | | | |
| Ld05 | LISTWA DYSTANSOWA ZAOKRĄGLONA „FAUN” 110 x 110 x 60 | | | | | |
| Ld06 | LISTWA DYSTANSOWA NAROŻNA OSTRA „FAUN” 110 x 110 x 60 | | | | | |
| Ld07 | LISTWA DYSTANSOWA ŚRODKOWA „3” 220 x 30 | | | | | |
| Ld08 | LISTWA DYSTANSOWA ZAOKRĄGLONA „3” 110 x 110 x 30 | | | | | |
| Ld09 | LISTWA DYSTANSOWA NAROŻNA OSTRA „3” 110 x 110 x 30 | | | | | |
| Ld10 | LISTWA DYSTANSOWA ŚRODKOWA GŁADKA „3” 220 x 30 | | | | | |

FORMULARZ ZAMÓWIENIA

CENY NETTO

v.7 obowiązuje od 01.01.2024

Do zapłaty * _____

* Wypełnić tylko w przypadku, gdy wymaga tego zamówienie

Zamówienie nr. _____

Nazwa _____

Kontakt _____

| Symbol | LISTWY DYSTANSOWE cd. | Cena | Kolor | Kolor | Ilość szt. | Ilość szt. |
|--------|--|------|-------|-------|------------|------------|
| Ld11 | LISTWA DYSTANSOWA ZAOKRĄGLONA GŁADKA „3” 110 x 110 x 30 | | | | | |
| Ld12 | LISTWA DYSTANSOWA OSTRZA GŁADKA „3” 110 x 110 x 30 | | | | | |
| Ld13 | LISTWA DYSTANSOWA ŚRODKOWA „VINTAGE” 220 x 60 | | | | | |
| Ld14 | LISTWA DYSTANSOWA ZAOKRĄGLONA „VINTAGE” 110 x 110 x 60 | | | | | |
| Ld15 | LISTWA DYSTANSOWA OSTRZA „VINTAGE” 110 x 110 x 60 | | | | | |
| Ld16 | LISTWA DYSTANSOWA ŁAMANA „VINTAGE” 110 x 110 x 60 | | | | | |
| Symbol | COKOŁY | Cena | Kolor | Kolor | Ilość szt. | Ilość szt. |
| C01 | COKÓŁ ŚRODKOWY „PROSTY” 220 x 155 x 60 | | | | | |
| C02 | COKÓŁ NAROŻNY OSTRY „PROSTY” 110 x 110 x 155 | | | | | |
| C07 | COKÓŁ NAROŻNY ZAOKRĄGLONY „PROSTY” 110 x 110 x 155 | | | | | |
| C03 | COKÓŁ ŚRODKOWY „PROFIL” 220 x 145 x 60 | | | | | |
| C04 | COKÓŁ NAROŻNY OSTRY „PROFIL” 110 x 110 x 145, 125 x 125 | | | | | |
| C08 | COKÓŁ NAROŻNY ZAOKRĄGLONY „PROFIL” 110x110x145, 125x125 | | | | | |
| C13 | COKÓŁ NAROŻNY ROZWARTY „PROFIL” 135° 110x110x145, 125x125 | | | | | |
| C05 | COKÓŁ ŚRODKOWY „OKNA” 220 x 160 x 50 | | | | | |
| C06 | COKÓŁ NAROŻNY OSTRY „OKNA” 110 x 110 x 160, 130 x 130 | | | | | |
| C09 | COKÓŁ NAROŻNY ZAOKRĄGLONY „OKNA” 110 x 110 x 160, 130 x 130 | | | | | |
| C10 | COKÓŁ ŚRODKOWY „DWORSKIE” 220 x 280 x 70 | | | | | |
| C11 | COKÓŁ NAROŻNY OSTRY „DWORSKIE” 200 x 200 x 280, 165 x 165 | | | | | |
| C12 | COKÓŁ ŚRODKOWY Z WYWIETRZNIKIEM „DWORSKIE” 220 x 280 x 70 | | | | | |
| C14 | COKÓŁ ŚRODKOWY „VINTAGE” 220 x 200 x 90 | | | | | |
| C15 | COKÓŁ NAROŻNY ZAOKRĄGLONY „VINTAGE” 220 x 220 x 200, 165 x 165 | | | | | |
| C16 | COKÓŁ NAROŻNY OSTRY „VINTAGE” 220 x 220 x 200, 165 x 165 | | | | | |
| C17 | COKÓŁ NAROŻNY ŁAMANY „VINTAGE” 220 x 220 x 200, 165 x 165 | | | | | |
| C18 | COKÓŁ ŚRODKOWY Z WYWIETRZNIKIEM „VINTAGE” 220 x 200 x 90 | | | | | |
| C19 | COKÓŁ ŚRODKOWY 135° „VINTAGE” 200 x 110 x 110 | | | | | |
| Symbol | GZYMSY | Cena | Kolor | Kolor | Ilość szt. | Ilość szt. |
| G01 | GZYMS ŚRODKOWY „KORONA” 220 x 170 | | | | | |
| G02 | GZYMS NAROŻNY OSTRY „KORONA” 165 x 55 x 170 | | | | | |
| G23 | GZYMS NAROŻNY ZAOKRĄGLONY „KORONA” 170 x 55 x 170 | | | | | |
| G03 | GZYMS ŚRODKOWY „NISKI” 220 x 120 | | | | | |
| G03/1 | GZYMS ŚRODKOWY „NISKI” 120 x 220 | | | | | |
| G04 | GZYMS NAROŻNY OSTRY „NISKI” 110 x 110 x 120, 165 x 165 | | | | | |
| G04/1 | GZYMS NAROŻNY OSTRY „NISKI” 165 x 165, 110 x 110 x 120 | | | | | |
| G17 | GZYMS NAROŻNY ZAOKRĄGLONY „NISKI” 110 x 110 x 120, 165 x 165 | | | | | |
| G17/1 | GZYMS NAROŻNY ZAOKRĄGLONY „NISKI” 165 x 165, 110 x 110 x 120 | | | | | |
| G24 | GZYMS NAROŻNY „NISKI” 135° 110 x 110 x 120, 165 x 165 | | | | | |
| G24/1 | GZYMS NAROŻNY „NISKI” 135° 165 x 165, 110 x 110 x 120 | | | | | |
| G05 | GZYMS ŚRODKOWY „MAKI” 220 x 150 x 60 | | | | | |
| G06 | GZYMS NAROŻNY OSTRY „MAKI” 110 x 110 x 150 | | | | | |
| G13 | GZYMS NAROŻNY ZAOKRĄGLONY „MAKI” 110 x 110 x 150 | | | | | |
| G07 | GZYMS ŚRODKOWY „LISTKI” 220 x 120 x 85 | | | | | |
| G07/1 | GZYMS ŚRODKOWY „LISTKI” 220 x 120 x 85 | | | | | |
| G08 | GZYMS NAROŻNY OSTRY „LISTKI” 110 x 110 x 120, 165 x 165 | | | | | |
| G08/1 | GZYMS NAROŻNY OSTRY „LISTKI” 165 x 165, 110 x 110 x 120 | | | | | |
| G09 | GZYMS NAROŻNY ZAOKRĄGLONY „LISTKI” 110 x 110 x 120, 165 x 165 | | | | | |
| G09/1 | GZYMS NAROŻNY ZAOKRĄGLONY „LISTKI” 165 x 165, 110 x 110 x 120 | | | | | |
| G10 | GZYMS ŚRODKOWY „OWAL” 220 x 100 x 85 | | | | | |
| G10/1 | GZYMS ŚRODKOWY „OWAL” 220 x 100 x 85 | | | | | |

FORMULARZ ZAMÓWIENIA

CENY NETTO

v.7 obowiązuje od 01.01.2024

Do zapłaty * _____

* Wypełnić tylko w przypadku, gdy wymaga tego zamówienie

Zamówienie nr. _____

Nazwa _____

Kontakt _____

K A F L A R N I A
KAFEL-KAR
 Hryniewicze 3B, 15-378 BIAŁYSTOK
 tel. 85 747 49 80
 kafle@kafel-kar.pl www.kafel-kar.pl

7

FORMULARZ ZAMÓWIENIA

CENY NETTO

| Symbol | GZYMSY cd. | Cena | Kolor | Kolor | Ilość szt. | Ilość szt. |
|---------|---|------|-------|-------|------------|------------|
| G11 | GZYMS GŁADKI ZAOKRĄGLONY „OWAL” 110 x 110 x 100, 165 x 165 | | | | | |
| G11/1 | GZYMS GŁADKI ZAOKRĄGLONY „OWAL” 165 x 165, 110 x 110 x 100 | | | | | |
| G12 | GZYMS NAROŻNY GŁADKI „OWAL” 110 x 110 x 100, 165 x 165 | | | | | |
| G12/1 | GZYMS NAROŻNY GŁADKI „OWAL” 165 x 165, 110 x 110 x 100 | | | | | |
| G18 | GZYMS NAROŻNY ZAOKRĄGLONY „OWAL” 165 x 165 x 100, 220 x 220 | | | | | |
| G18/1 | GZYMS NAROŻNY ZAOKRĄGLONY „OWAL” 220 x 220, 165 x 165 x 100 | | | | | |
| G19 | GZYMS NAROŻNY OSTRY „OWAL” 165 x 165 x 100, 220 x 220 | | | | | |
| G19/1 | GZYMS NAROŻNY OSTRY „OWAL” 220 x 220, 165 x 165 x 100 | | | | | |
| G20 | GZYMS NAROŻNY Podcokolnik „OWAL” 165 x 165 x 100, 220 x 220 | | | | | |
| G21 | GZYMS NAROŻNY ŁAMANY „OWAL” 165 x 165, 110 x 110 x 100 | | | | | |
| G22 | GZYMS NAROŻNY WEWNĘTRZNY „OWAL” 165 x 165 x 100, 110 x 110 | | | | | |
| G22/1 | GZYMS NAROŻNY WEWNĘTRZNY „OWAL” 110 x 110, 165 x 165 x 100 | | | | | |
| G14 | GZYMS ŚRODKOWY „WYSOKI” 440 x 200 x 100 | | | | | |
| G14/1 | GZYMS ŚRODKOWY „WYSOKI” 440 x 200 x 100 | | | | | |
| G15 | GZYMS NAROŻNY ZAOKR. „WYSOKI” 110 x 110 x 200, 165 x 165 | | | | | |
| G15/1 | GZYMS NAROŻNY ZAOKR. „WYSOKI” 165 x 165, 110 x 110 x 200 | | | | | |
| G16 | GZYMS NAROŻNY OSTRY „WYSOKI” 110 x 110 x 200, 165 x 165 | | | | | |
| G16/1 | GZYMS NAROŻNY OSTRY „WYSOKI” 165 x 165, 110 x 110 x 200 | | | | | |
| Dw07 | GZYMS ŚRODKOWY 220 x 120 | | | | | |
| Dw07/1 | GZYMS ŚRODKOWY 220 x 120 x 110 | | | | | |
| Dw09L | GZYMS NAROŻNY OSTRY 220 x 110 x 120, 275 x 165, R-2 LEWY | | | | | |
| Dw09L/1 | GZYMS NAROŻNY OSTRY 275 x 165, 220 x 110 x 120, R-2 LEWY | | | | | |
| Dw09P | GZYMS NAROŻNY OSTRY 220 x 110 x 120, 275 x 165, R-2 PRAWY | | | | | |
| Dw09P/1 | GZYMS NAROŻNY OSTRY 275 x 165, 220 x 110 x 120, R-2 PRAWY | | | | | |
| Symbol | KAFLE WYKOŃCZENIOWE, DEKORACYJNE | Cena | Kolor | Kolor | Ilość szt. | Ilość szt. |
| Kz08 | KORONA DUŻA „NENUFARY” 660 x 340, 880 x 340 x 110 z narożnikami | | | | | |
| Kz09 | KORONA MAŁA „NENUFARY” 440 x 340 | | | | | |
| Kz10 | NAROŻNIK „NENUFARY” 110 x 110 x 210 | | | | | |
| Kz11 | ELEMENT MODUŁOWY WYPEŁNIAJĄCY „NENUFARY” 220 x 110 | | | | | |
| L01 | KAFEL ŁUK NAROŻNY 220 x 220 x 100 | | | | | |
| L02 | KAFEL ŁUK ŚRODKOWY 220 x 100 | | | | | |
| L03 | ELEMENT OZDOBNY NAROŻNIK DUŻY „KOLUMNA” 665 x 165 x 165 | | | | | |
| L09 | EL. OZDOBNY NAROŻNIK DUŻY „KOLUMNA Vintage” 665 x 165 x 165 | | | | | |
| L10 | EL. OZDOBNY NAROŻNIK DUŻY „KOLUMNA Ogarek” 665 x 165 x 165 | | | | | |
| L11 | ELEMENT OZDOBNY „JELEŃ” 660 x 440 x 20 | | | | | |
| L04 | ELEMENT OZDOBNY „DWOREK” 660 x 440 x 25 | | | | | |
| L05 | ELEMENT OZDOBNY „OSTY” 530 x 335 x 55 | | | | | |
| L12 | ELEMENT OZDOBNY „KOŃ” 535 x 340 x 75 | | | | | |
| L06 | POSTUMENT 134 x 134 x 200, (78 x 78 podstawa) | | | | | |
| L07 | POSTUMENT OWALNY ø120 x 70, kryza ø60 | | | | | |
| L08 | KAFEL OZDOBNY „OSTY” 220 x 220 x 50 | | | | | |
| Symbol | KAFLE „SECESJA” | Cena | Kolor | Kolor | Ilość szt. | Ilość szt. |
| Z01 | KORONA DUŻA Z NAROŻNIKAMI 910 x 520 x 85 | | | | | |
| Z01a | NAROŻNIK 85 x 85 x 240 | | | | | |
| Z01bP | ELEMENT MODUŁOWY WYPEŁNIAJĄCY PRAWY 220 x 210 | | | | | |
| Z01bL | ELEMENT MODUŁOWY WYPEŁNIAJĄCY LEWY 220 x 210 | | | | | |
| Z02 | KORONA MAŁA 495 x 295 x 85 | | | | | |
| Z03 | LISTWA ZDOBIONA Z NAROŻNIKAMI 910 x 155 x 97 | | | | | |
| Z03a | NAROŻNIK 97 x 97 x 155 | | | | | |

v.7 obowiązuje od 01.01.2024

Do zapłaty * _____

* Wypełnić tylko w przypadku, gdy wymaga tego zamówienie

Zamówienie nr. _____

K A F L A R N I A
KAFEL-KAR
 Hryniewicze 3B, 15-378 BIAŁYSTOK
 tel. 85 747 49 80
 kafle@kafel-kar.pl www.kafel-kar.pl

8

Nazwa _____

Kontakt _____

| Symbol | KAFLE „SECESJA” cd. | Cena | Kolor | Kolor | Ilość szt. | Ilość szt. |
|--------|---|------|-------|-------|------------|------------|
| Z04 | LISTWA ZDOBIONA BEZ NAROŻNIKÓW 715 x 155 x 60 | | | | | |
| Z05/1 | ELEMENT OZDOBNY „MAKI 1” 535 x 340 x 75 | | | | | |
| Z05/1D | ELEMENT OZDOBNY „MAKI 1” DUŻY 660 x 415 x 75 | | | | | |
| Z05/2 | ELEMENT OZDOBNY „MAKI 2” 510 x 340 x 65 | | | | | |
| Z06 | GZYMS ZDOBIONY NAROŻNY PIONOWY 105 x 105 x 325 | | | | | |
| Z07 | GZYMS ZDOBIONY NAROŻNY / ŚRODKOWY WYPEŁ. 105 x 105 x 220 | | | | | |
| Z08 | LISTWA ZDOBIONA ŚRODKOWA POZIOMA 300 x 100 x 50 | | | | | |
| Z09 | GZYMS ŚRODKOWY „PRZEWĘŻENIE” 220 x 105 x 92 | | | | | |
| Z10L | GZYMS NAROŻNY „PRZEWĘŻENIE” LEWY 220 x 110 x 92, 275 x 165 | | | | | |
| Z10P | GZYMS NAROŻNY „PRZEWĘŻENIE” PRAWY 220 x 110 x 92, 275 x 165 | | | | | |
| Z11 | KAFEL OZDOBNY ŚRODKOWY 220 x 220 x 50 | | | | | |
| Z12 | KAFEL OZDOBNY NAROŻNY OSTRY 220 x 110 x 110 | | | | | |
| Z13 | KAFEL OZDOBNY PÓŁÓWKA ½ 220 x 110 x 50 | | | | | |
| Z14 | KAFEL OZDOBNY Z WYWIETRZNIKIEM 220 x 220 x 50 | | | | | |
| Symbol | PIEC OKRĄGŁY „KLASYCZNY” | Cena | Kolor | Kolor | Ilość szt. | Ilość szt. |
| Ko01 | GZYMS 247 x 175, R ~402 | | | | | |
| Ko02 | GZYMS PRZEWĘŻENIE 247 x 227 x 80, R~402 | | | | | |
| Ko02/1 | GZYMS PRZEWĘŻENIE 227 x 247 x 80, R~370 | | | | | |
| Ko03 | KAFEL ŚRODKOWY 280 x 227, R ~370 | | | | | |
| Ko04 | KAFEL ŚRODKOWY 330 x 247, R ~402 | | | | | |
| Ko05 | PÓŁKA 227 x 30, R ~370 | | | | | |
| Ko12 | PÓŁKA 247 x 30, R ~402 | | | | | |
| Ko13 | PÓŁKA 280 x 90 x 120, R ~402 | | | | | |
| Ko06 | LISTWA ZDOBIONA 227 x 140 | | | | | |
| Ko07 | LISTWA MASKUJĄCA BRZEGOWA „2” 280 x 70 x 20 | | | | | |
| Ko08 | COKÓŁ 247 x 120, R ~402, R~460 | | | | | |
| Ko09 | KAFEL ŚRODKOWY Z WYWIETRZNIKIEM 280 x 227, R ~370 | | | | | |
| Ko10 | KAFEL ŚRODKOWY Z WYWIETRZNIKIEM 330 x 247, R ~402 | | | | | |
| Ko11 | DEKIELEK ø190 | | | | | |
| Ko14L | KAFEL Z WYCIĘCIEM POD RURĘ DYMOWĄ 280 x 227, R ~370, ø190 | | | | | |
| Ko14P | KAFEL Z WYCIĘCIEM POD RURĘ DYMOWĄ 280 x 227, R ~370, ø190 | | | | | |
| Ko15 | LISTWA ZDOBIONA „MAKI ” 150 x 227, R~370 | | | | | |
| Ko16 | COKÓŁ „PROFIL” 145 x 240, R~370 | | | | | |
| Symbol | PIEC OKRĄGŁY „OGAREK ø 90” | Cena | Kolor | Kolor | Ilość szt. | Ilość szt. |
| Ver. A | CZASZA KOMPLET (buławka, podstawa buławki, czasza, baza) wys. 640 | | | | | |
| Ver. B | WAZA KOMPLET (waza, podstawa wazy, blat, kafel baza) wys. 560 | | | | | |
| Or01 | „BUŁAWKA” ø87, wys.145 | | | | | |
| Or02 | PODSTAWA „BUŁAWKI” ø195, wys. 92 | | | | | |
| Or03 | CZASZA ø565, wys. 270 | | | | | |
| Or04 | WAZA ø565, wys. 270 | | | | | |
| Or05 | PODSTAWA WAZY ø336, wys.156 | | | | | |
| Or06 | PÓŁKA KRYJĄCA (BLAT), R~278, wys.15 | | | | | |
| Or07 | KAFEL BAZA pod CZASZĘ i WAZĘ, R~370, wys. 110 | | | | | |
| Or08 | DEKIELEK ø190 | | | | | |
| Or09 | KAFEL KRYJĄCY 265 x 247, R - 350 | | | | | |
| Or10 | GZYMS WIEŃCZĄCY 325 x 75 x 140, R~425 | | | | | |

FORMULARZ ZAMÓWIENIA

CENY NETTO

v.7 obowiązuje od 01.01.2024

* Wypełnić tylko w przypadku, gdy wymaga tego zamówienie

Do zapłaty * _____

Zamówienie nr. _____

Nazwa _____

Kontakt _____

| Symbol | PIEC OKRĄGLY „OGAREK ø 90” cd. | Cena | Kolor | Kolor | Ilość szt. | Ilość szt. |
|--------|---|------|-------|-------|------------|------------|
| Or11 | KAFEL ŚRODKOWY 360 x 282 x 50, R~370 | | | | | |
| Or12 | KAFEL ŚRODKOWY WENTYLACYJNY 360 x 282 x 50, R~370 | | | | | |
| Or13 | PÓŁKA 365 x 130 x 140, R~450 | | | | | |
| Or14 | KAFEL ŚRODKOWY 400 x 341 x 50, R~450 | | | | | |
| Or15 | KAFEL ŚRODKOWY WENTYLACYJNY, 400 x 341 x 50, R~450 | | | | | |
| Or16 | COKÓŁ 250 x 400 x 85, R~450 | | | | | |
| Or17 | KAFEL NAROŻNY (RAMOWY_v.A) 400 x 341 x 30, R~450 | | | | | |
| Or18 | KAFEL NAROŻNY (RAMOWY_v.A) 400 x 341 x 30, R~450 | | | | | |
| Or19 | KAFEL ŚRODKOWY (RAMOWY_v.A) 341 x 30, wys. 110, R~450 | | | | | |
| Or20 | KAFEL NAROŻNY (RAMOWY_v.B) 400 x 341 x 30, R~450 | | | | | |
| Or21 | KAFEL NAROŻNY (RAMOWY_v.B) 400 x 341 x 30, R~450 | | | | | |
| Or22 | KAFEL ŚRODKOWY (RAMOWY_v.B) 341 x 30, wys.140, R~450 | | | | | |
| Or23 | KAFEL ŚRODKOWY 360 x 282 x 50, R~370 Z OTWOREM ø190 | | | | | |

Uwaga! v.A - Kafle Or17, Or18, Or19 przeznaczone do wersji wkładu o wysokości 57cm

v.B - Kafle Or20, Or21, Or22 przeznaczone do wersji wkładu o wysokości 51cm

| Symbol | PIEC OKRĄGLY „OGAREK ø 66” | Cena | Kolor | Kolor | Ilość szt. | Ilość szt. |
|--------|---|------|-------|-------|------------|------------|
| OrM01 | DEKIELEK ø190 | | | | | |
| OrM02 | KAFEL KRYJĄCY 234 x 211, R~310 | | | | | |
| OrM03 | GZYMS WIEŃCZĄCY 287 x 67 x 120, R~380 | | | | | |
| OrM04 | COKÓŁ 287 x 67 x 120, R~380 | | | | | |
| OrM05 | LISTWA ZDOBIONA 250 x 40, R~330 | | | | | |
| OrM06 | KAFEL ŚRODKOWY 260 x 250 x 36, R~330 | | | | | |
| OrM07 | KAFEL ŚRODKOWY WENTYLACYJNY 260 x 250 x 36, R~330 | | | | | |
| OrM08 | KAFEL ŚRODKOWY RAMOWY 260 x 250 x 36, R~330 | | | | | |
| OrM09 | LISTWA RAMOWA PIONOWA 260 x 46 x 22 | | | | | |
| OrM10 | KAFEL ŚRODKOWY 260 x 250 x 36, R~330 Z OTWOREM ø190 | | | | | |
| Symbol | KAFLE „RURA CERAMICZNA Z ROZETAMI” | Cena | Kolor | Kolor | Ilość szt. | Ilość szt. |
| Ru01 | ROZETA RURY CERAMICZNEJ (ŚCIENNA) ø380 x 80, otw. ø266 | | | | | |
| Ru02 | ROZETA RURY CERAMICZNEJ (PIECOWA) ø380 x 80, otw. ø266 | | | | | |
| Ru03 | RURA CERAMICZNA ø256 x 400, otw. ø222 | | | | | |
| Symbol | KAFLE „KWADRATELE” | Cena | Kolor | Kolor | Ilość szt. | Ilość szt. |
| P01 | KAFEL ŚRODKOWY 205 x 130 x 45 | | | | | |
| P02 | KAFEL NAROŻNY 205 x 130 x 105 | | | | | |
| !! P03 | KAFEL POŁÓWKA ½ 102,5 x 130 x 45 | | | | | |
| !! P04 | KAFEL ŚRODKOWY WENTYLACYJNY 205 x 130 x 45 | | | | | |
| P05 | KAFEL WIEŃCOWY ŚRODKOWY 400 x 85 x 55 | | | | | |
| P06 | KAFEL WIEŃCOWY LEWY 400 x 85 x 55 | | | | | |
| P07 | KAFEL WIEŃCOWY PRAWY 400 x 85 x 55 | | | | | |
| P08 | KAFEL OKAPNIKOWY 130 x 130 x 130 | | | | | |
| P09 | KAFEL ŚRODKOWY Z OTWOREM 125 x 85, 205 x 130 x 45 | | | | | |
| P10 | KOREK 140 x 95 x 35 | | | | | |
| Symbol | PIECE MINIATURY | Cena | Kolor | Kolor | Ilość szt. | Ilość szt. |
| M01 | MINIATURA PIECA ROGALIŃSKIEGO 105 x 80 x 290, Wymiary opakowania - 140 x 100 x 325 | | | | | |

FORMULARZ ZAMÓWIENIA

CENY NETTO

v.7 obowiązuje od 01.01.2024

!! - NOWOŚĆ

* Wypełnić tylko w przypadku, gdy wymaga tego zamówienie

Do zapłaty * _____



PIECYK „ECHO”

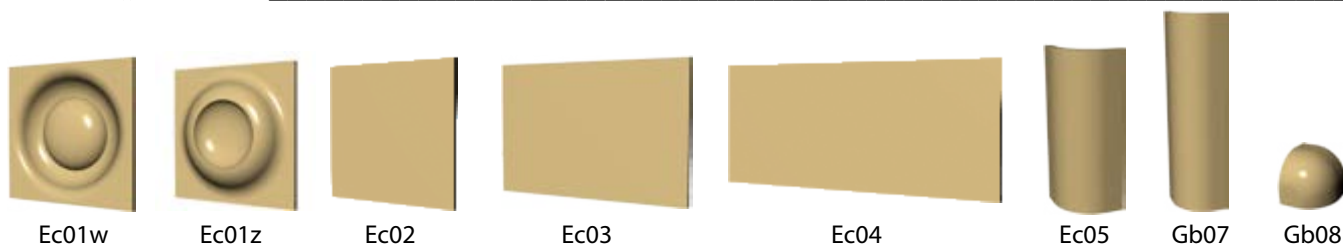

KAFLE „BRAMA”



KAFLE „TALERZ CIĘTY”



KAFLE „GŁADKIE”



KAFLE „RAMKOWE” _____ s. 15



KAFLE „DWORSKIE” _____ s. 18



KAFLE „FORMAT” 28 cm _____ s. 24

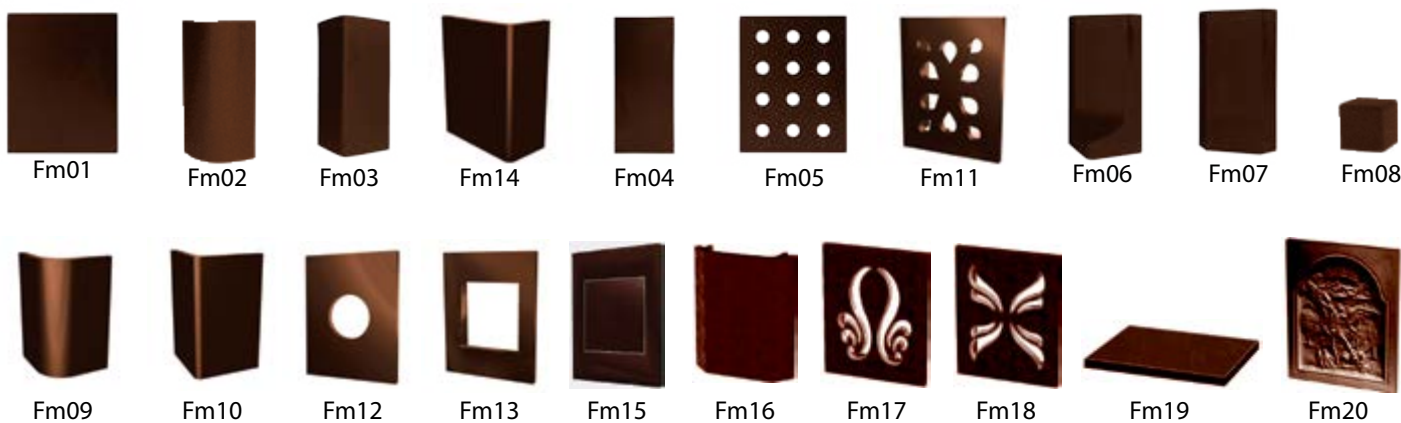

KAFLE „OGARKI” _____ s. 26



KAFLE „VINTAGE” _____ s. 30



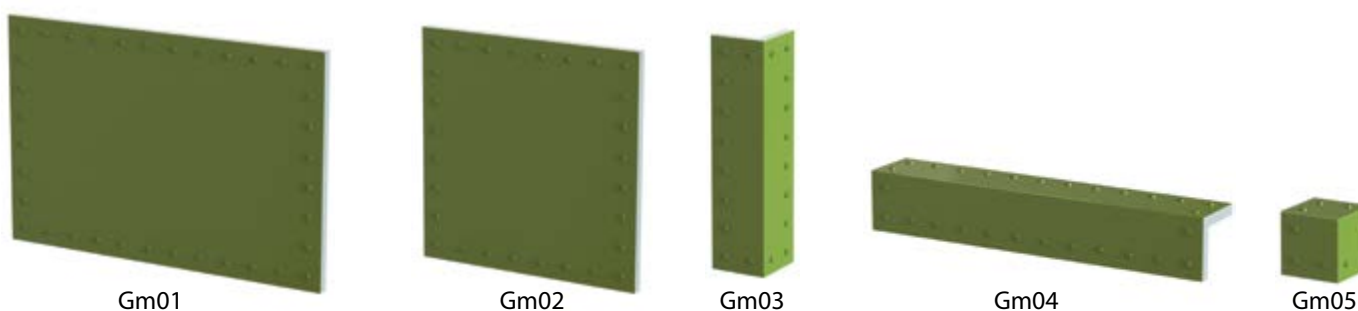
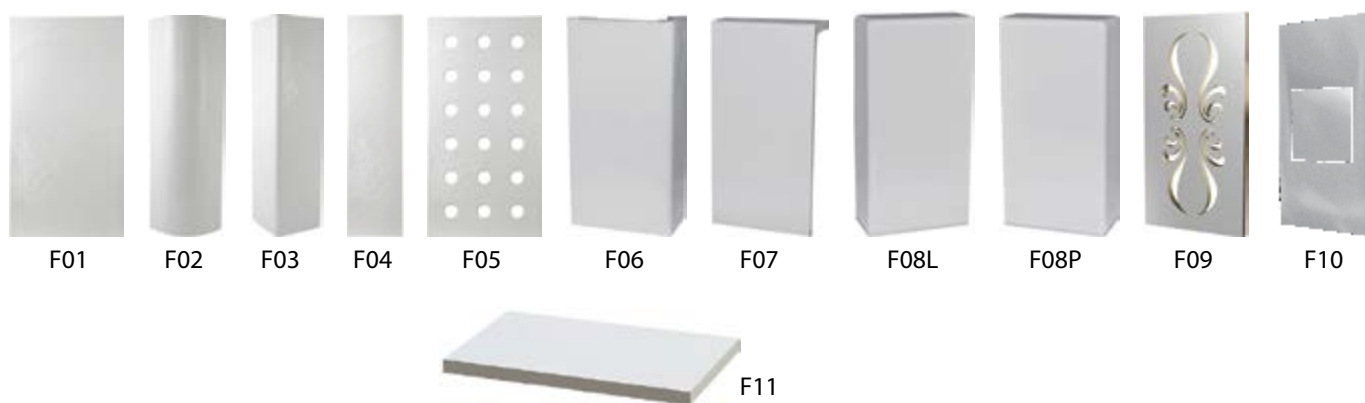

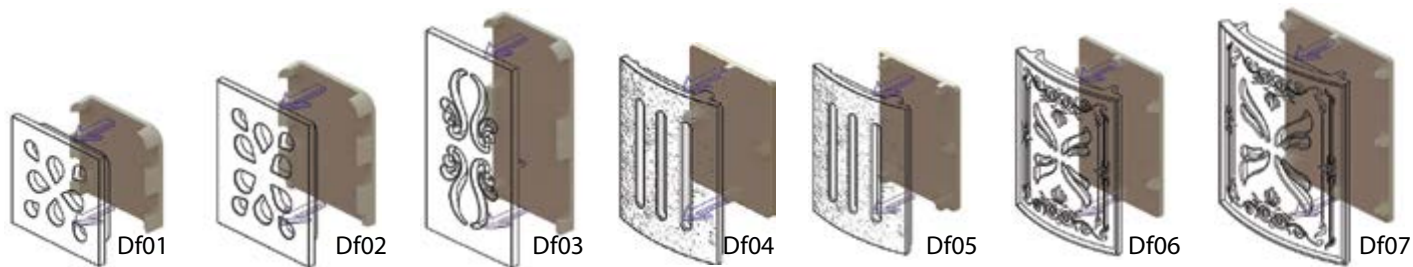

KAFLE PÓŁKI „6” _____ s. 45

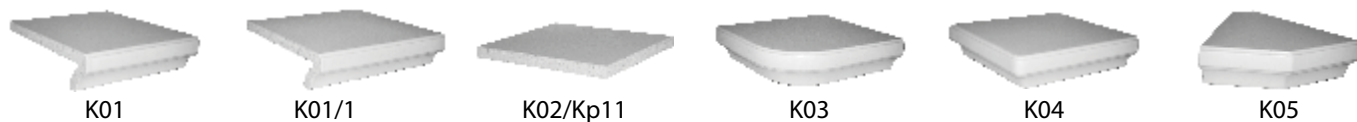

KAFLE WIEŃCOWE „6” _____ s. 46



PÓŁKI „3” SLIM _____ s. 47



KAFLE PÓŁKI „WYSOKIE” _____ s. 48



KAFLE PÓŁKI „SECESJA” _____ s. 49



KAFLE PÓŁKI „ZDOBIONE” _____ s. 50



KAFLE PÓŁKI „VINTAGE” _____ s. 51





COKOŁY



GZYMŚY





Kz08



Kz09



Kz10



Kz11



L01



L02



L03



L04



L05



L12



L06



L07



L08



L11



L09



L10

„KAFLE SECESJA”



Z01



Z01a



Z01bL



Z01bP



Z02



Z03



Z05/1



Z05/1D



Z05/2



Z06



Z07



Z03a



Z04



Z08



Z09



Z10L



Z10P



Z11



Z12



Z13



Z14

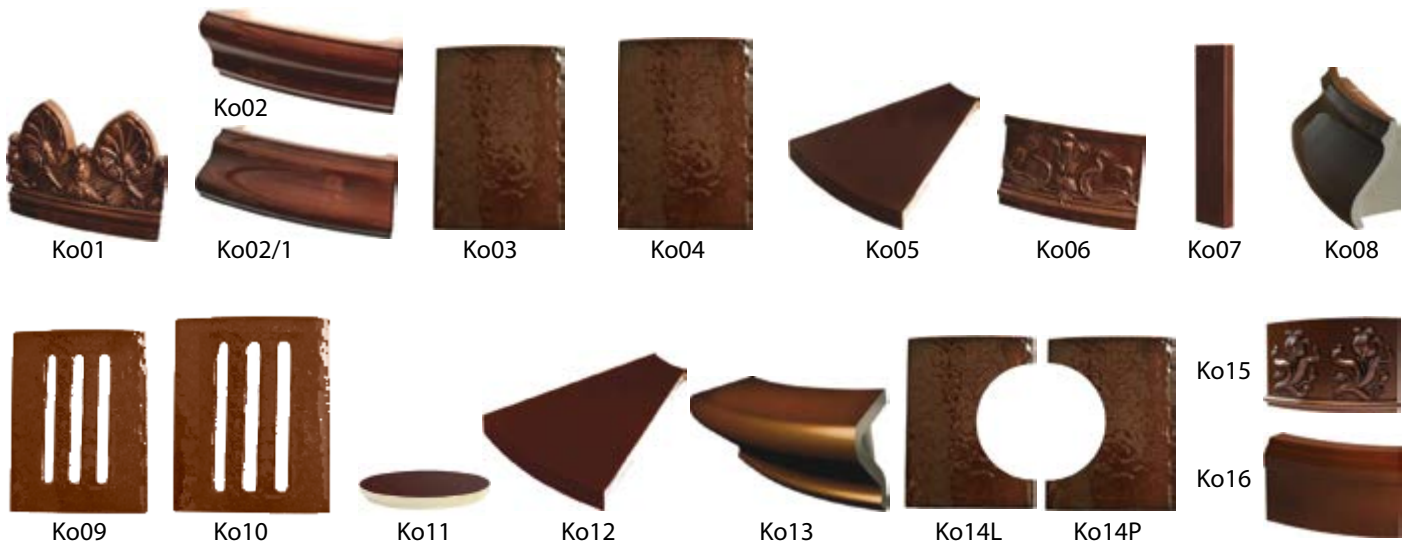

PIEC OKRĄGŁY „OGAREK Ø66” _____ s. 91



KAFLE „RURA CERAMICZNA Z ROZETAMI” _____ s. 94



PIECE MINIATURY _____ s. 95



KAFLE „KWADRATELE” _____ s. 97

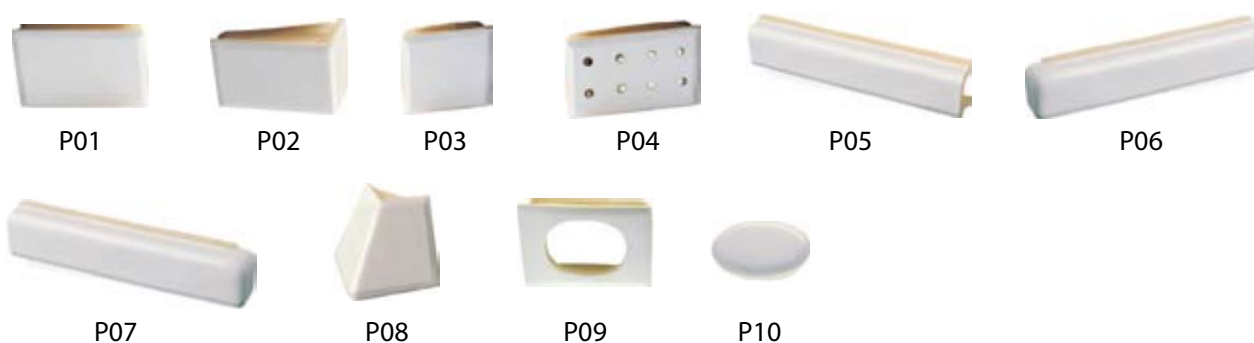



ceramic Wall

m a n u f a k t u r a

Panele dekoracyjne CeramicWall

Elegancja, finezyjny design i gustowna estetyka – panele ściennie CeramicWall potrafią zaintrygować, zachwycić oraz zainspirować. Są bowiem wyjątkową formą ceramiki dekoracyjnej, tworzonej na potrzeby wykończeń, aranżacji oraz dekoracji wnętrz, zarówno mieszkalnych, jak i użytkowych. Ornamenty i mozaiki ściennie CeramicWall doskonale prezentują się w pomieszczeniach mieszkalnych, w łazienkach, kuchniach, sypialniach, salonach, a także w obiektach użyteczności publicznej, w biurach oraz holach. Bogata różnorodność wzorów i stylizacji wychodzi naprzeciw nawet najbardziej wyrafinowanemu gustom, tym bardziej, że możliwości stosowania połączeń i kombinacji są wręcz nieograniczone. Gdy dodamy do tego bardzo istotne walory użytkowe, takie jak trwałość i łatwość w utrzymaniu czystości, otrzymujemy pełny obraz zalet wyrobów CeramicWall – nietuzinkowych paneli ceramicznych dla każdego!

Rozejrzyj się, a znajdziesz idealne rozwiązanie dla Siebie!

Możliwości projektowe

Wprawdzie katalog wzorów ceramiki ściennej CeramicWall stanowi sam w sobie bogate źródło inspiracji i możliwości, to oczywiście nic nie stoi na przeszkodzie, by poszybować swobodnie na skrzydłach wyobraźni. Nasi doświadczeni projektanci są zawsze gotowi na nowe wyzwania, by sprostać Państwa życzeniom oraz twórczym wizjom. Posiadamy nowoczesne zaplecze technologiczne, umożliwiające zaprojektowanie i wykonanie dowolnych ornamentów ściennych na podstawie dostarczonych rysunków, zdjęć lub szkiców. Możemy także wykonać projekt draperii ściennej wyłącznie na podstawie opisu konkretnego pomysłu lub koncepcji.

CeramicWall – ceramika dekoracyjna bez ograniczeń –
twórz razem z nami!

Zawsze jesteśmy otwarci na nowe wyzwania!

www.ceramicwall.pl





**K A F L A R N I A
KAFEL-KAR**

15-378 Białystok, Hryniewicze 3 B
tel. 85 747 49 80, kafle@kafel-kar.pl
NIP: 966-134-14-58 REGON: 200212517
Bank Spółdzielczy w Juchnowcu Górnym
50 8074 0003 0008 0190 3000 0010